

# STATUS OF WATER TREATMENT PLANTS IN INDIA



**CENTRAL POLLUTION CONTROL BOARD**  
(MINISTRY OF ENVIRONMENT AND FORESTS)

Website : [www.cpcb.nic.in](http://www.cpcb.nic.in)

e-mail : [cpcb@nic.in](mailto:cpcb@nic.in)

## CONTENTS

1. INTRODUCTION
2. Water QUALITY AND ITS CONSUMPTION
3. WATER TREATMENT TECHNOLOGIES
4. EFFECTS OF FLOURIDE & ARSENIC AND REMOVAL TECHNIQUES
5. OPERATION & MAINTENANCE OF WATER TREAT PLANTS
6. WATER QUALITY CONTROL AND ASSESSMENT
7. RESULTS AND DISCUSSION
  - ANNEXURE-1
  - ANNEXURE-2
  - ANNEXURE-3
  - ANNEXURE-4
  - ANNEXURE-5
  - CONTRIBUTERS

## **1.0 INTRODUCTION**

### **1.1 Preamble**

Water is a precious commodity. Most of the earth water is sea water. About 2.5% of the water is fresh water that does not contain significant levels of dissolved minerals or salt and two third of that is frozen in ice caps and glaciers. In total only 0.01% of the total water of the planet is accessible for consumption. Clean drinking water is a basic human need. Unfortunately, more than one in six people still lack reliable access to this precious resource in developing world.

India accounts for 2.45% of land area and 4% of water resources of the world but represents 16% of the world population. With the present population growth-rate (1.9 per cent per year), the population is expected to cross the 1.5 billion mark by 2050. The Planning Commission, Government of India has estimated the water demand increase from 710 BCM (Billion Cubic Meters) in 2010 to almost 1180 BCM in 2050 with domestic and industrial water consumption expected to increase almost 2.5 times. The trend of urbanization in India is exerting stress on civic authorities to provide basic requirement such as safe drinking water, sanitation and infrastructure. The rapid growth of population has exerted the portable water demand, which requires exploration of raw water sources, developing treatment and distribution systems.

The raw water quality available in India varies significantly, resulting in modifications to the conventional water treatment scheme consisting of aeration, chemical coagulation, flocculation, sedimentation, filtration and disinfection. The backwash water and sludge generation from water treatment plants are of environment concern in terms of disposal. Therefore, optimization of chemical dosing and filter runs carries importance to reduce the rejects from the water treatment plants. Also there is a need to study the water treatment plants for their operational status and to explore the best feasible mechanism to ensure proper drinking water production with least possible rejects and its management. With this backdrop, the Central Pollution Control Board (CPCB), studied water treatment plants located across the country, for prevailing raw water quality, water treatment technologies, operational practices, chemical consumption and rejects management.

This document presents study findings and views for better management of water treatment plants.

## **1.2 Methodology**

The methodology consists of three phases, as below:

1. Questionnaire survey
2. Field studies (dry and wet studies) and
3. Compilation of informations

## **1.3 Questionnaire Survey**

Preliminary survey for population, source of water, type of water treatment schemes and capacity of water treatment plants at Class I towns were done by questionnaire survey. A copy of the questionnaire is given at **Annexure 1**. Subsequently, State Pollution Control Boards and State Public Health Engineering Department were also approached for obtaining informations. As a result some of the towns, which were not listed, also responded.

Finally, 126 towns responded against targeted 229 Class I towns and in addition 76 other towns were also responded. In total 202 received responses are summarized at **Annexure 2**, which reveals that in many of the cities, the water source remain surface water.

## **1.4 Field Studies**

In the filed studies, 52 water treatment plants in various parts of the country from East to West and North to South were visited. Detailed information on raw water quality, treated water quality, organizational structure for Operation and Maintenance (O&M) of water treatment plants, operational status / problems, and information on mode of disposal of filter backwash waters & clarifier sludge was collected. In the study, all the metropolitan of the country have been covered. Apart from geographical location, the size of water treatment plant and type of treatment units were also taken into account while making selection of water treatment plant for visits.

Water treatment plants up to Jammu in North, up to Thiruvananthapuram in South, up to Kolkata in east and up to Mumbai in west have been visited. During the detailed study, samples of filter backwash water and clarifier sludge

had been collected from 30 plants, which are listed in **Annexure 3**. Plants for fluoride and arsenic removal have also been covered in the study. These water treatment plants not only cover different capacities but also different technologies. The details obtained during the visits and also from wet analysis are discussed at appropriate chapters.

## 1.5 **Compilation of Information**

Of the fifty two plants studied, two were for fluoride removal and one was for arsenic removal. For these three plants, water source was ground water and these plants were of very small capacity. In fact, two were attached to hand pumps. Remaining water treatment plants have surface water as a water source and hence for all these plants, the treatment system is principally same i.e. removal of turbidity and disinfection. The collected information is processed and broad observations on various treatment plants are as follows:

- At many water treatment plants, the raw water is very clean having turbidity less than 10 NTU during non-monsoon period. Whenever the turbidity is so low, alum or Poly Aluminium Chloride (PAC) is not added, although the water passes through all the units such as flocculators and settling tanks before passing through rapid sand filters.
- Alum is being added as coagulant in almost all Water Treatment Plants, however, recently water treatment plant at Nasik and Pune have started using PAC instead of alum, which is in liquid form. The water treatment plant personal appeared to prefer PAC as no solution is to be prepared, as in case of alum. Bhandup water treatment complex, Mumbai is using aluminium ferric sulphate, which is one of the biggest water treatment plant in India.
- In few plants, non mechanical devices such as hydraulic jumps are being used for mixing of chemicals. Also, paddles of flash mixer were non functional in some water treatment plants.
- Some of the water treatment plants are using bleaching powder for chlorination, while majority are using liquid chlorine. The operation and maintenance of chlorinator was far from satisfactory and chlorine dosing is often on approximation. Instrumentation part in terms of chemical addition and chlorination appeared to be imperfect in most of the plants. Some

water treatment plants were using alum bricks directly instead of making alum solution before addition.

- In few plants, tapered flocculation units with flocculator of varying speeds are in use. In this case the settling tanks are rectangular with hopper bottom. These tanks do not have mechanical scraping arrangement and are cleaned during the period of filter backwash.
- Pre-chlorination dose, in case of Agra water treatment plant was reported to be high as 60 mg/l, which is a matter of great concern for water treatment plant authorities. This is because raw water BOD is very high due to discharge of industrial effluents on the upstream side of water treatment plant intake.
- All the water treatment plants (except defluoridation plants) have rapid sand filters. In addition to rapid sand filters, slow sand filters were in operation at Aish Bagh, Lucknow and Dhalli, Shimla. At Nasik, water treatment plant had dual media filter using coconut shell as second medium, which is being replaced by sand.
- Filter runs are generally longer about 36 to 48 Hrs. during non-monsoon period except Sikendara WTP, Agra where filter runs are shorter during this period due to algae problem all though rapid sand filters are located in a filter house. This is due to high pollution (BOD) of raw water. Normally, wherever rapid sand filters are located in filter house, algae problem is not encountered. Some of water treatment plants, where rapid sand filters are in open, algae problem is overcome by regular cleaning of filter walls or pre-chlorination.
- Mostly, filter backwash waters & sludge from water treatment plants are being discharged into nearby drains, which ultimately meet the water source on downstream side of intake. However, exception is at Sikandara water treatment plants, Agra, where sludge and filter back wash waters are discharged on upstream side of water intake in Yamuna River.
- In some of the water treatment plants, clarifiers are cleaned once in a year and the sludge are disposed off on nearby open lands. AT Haiderpur Water Works in Delhi, reuse of sludge and filter back wash water is under consideration. In case of Dew Dharam water treatment plant at Indore and Narayangiri water treatment plant at Bhopal, the backwash water is being

used for gardening, while at Balaganj water treatment plant, Lucknow, filter backwash water is recycled by way of sedimentation and feeding them at inlet of water treatment plant.

- In many cases, details of water treatment plant units such as their sizes, specifications, layout etc are not available. This is possibly because of water treatment plant executing agency and water supply system operation & maintenance agency are different. Water treatment plant operation manual were also not available at many plants.
- In most of the cases, adequacy of water treatment from health point of view is ensured by maintaining residual chlorine of 0.2 to 0.1 mg/l at the farthest point of distribution system. Very few water treatment plants have facilities for MPN testing.
- Water treatment plants are either operated or maintained by Public Health Engineering Departments or local municipal corporations. At Shimla, water treatment plant is under Irrigation and Public Health (IPH) of the Himachal State Government, whereas water distribution is looked after by Shimla Municipal Corporation.
- Operation and maintenance of Sikandara water treatment plant, Agra; Red Hills Water Treatment Plant, Chennai; Peddapur water treatment plant, Hyderabad and Kotarpur water treatment plant, Ahmedabad have been assigned to the private organizations. In Uttar Pradesh, execution of water treatment plant is carried out by UP Jal Nigam and operation & maintenance is carried out by UP Jal Sansthan, not by local municipalities.
- Okhla water works, Delhi gets raw water from rainy well and is subjected to ozonation and denitrification. Operation and maintenance of ozonators and denitrification plant is being looked after by a private organization. It has been learned that ozonation is being carried out principally for iron removal and not for disinfection.
- Typical problem of excess manganese is faced at Kolar water treatment plant, Bhopal during May to October. This problem is being tackled by adding  $KMNO_4$  and lime at the inlet. In Surat, at Katargam water works, raw water is coloured. The treatment plant is having proper O&M, could remove colour.

- Mundali water treatment plant at Bhubaneswar has a capacity to treat 115 MLD, but in practical operated for 1 shift to treat 40 MLD water. Whereas, Palasuni water works at Bhubaneshwar is having capacity of 81.8 MLD, but plants are overloaded to a total of 106.5 MLD.
- Kotarpur water treatment plant located at Ahmedabad has a capacity of 600 MLD, but treating only 300 MLD, due to shortage of raw water.
- State of art water treatment plant exists at T.K. Halli, Bangalore, which has all the operation computerized. This plant has pulsator type clarifiers and plant authorities appeared to be worried about excess chemical consumption and dilute sludge from these clarifiers. At this plant, clarifier sludge is being conditioned with polyelectrolyte and dewatered by vacuum filters. Filter backwash waters are discharged into the nearby drain. The distance of Water treatment plant is more than 80 kms from Bangalore city. Looking at the distance, it may be appropriate to have chlorination facility near to the city and near the point from where distribution starts.



## 2.0 WATER QUALITY AND ITS CONSUMPTION

### 2.1 Water and its Quality

Water is colorless, tasteless, and odorless. It is an excellent solvent that can dissolve most minerals that come in contact with it. Therefore, in nature, water always contains chemicals and biological impurities i.e. suspended and dissolved inorganic and organic compounds and micro organisms. These compounds may come from natural sources and leaching of waste deposits. However, Municipal and Industrial wastes also contribute to a wide spectrum of both organic and inorganic impurities. Inorganic compounds, in general, originate from weathering and leaching of rocks, soils, and sediments, which principally are calcium, magnesium, sodium and potassium salts of bicarbonate, chloride, sulfate, nitrate, and phosphate. Besides, lead, copper, arsenic, iron and manganese may also be present in trace amounts. Organic compounds originate from decaying plants and animal matters and from agricultural runoffs, which constitute natural humic material to synthetic organics used as detergents, pesticides, herbicides, and solvents. These constituents and their concentrations influence the quality and use of the natural water resource.

Primary water quality criteria for designated best classes (for drinking water, outdoor bathing, propagation of wildlife & fisheries, irrigation, industrial cooling) have been developed by the Central Pollution Control Board. The limits for criteria pollutants are given at **Table 2.1**.

**Table 2.1: Primary Water Quality Criteria for Designated Best Use Classes**

S.No.	Designated best use	Class	Criteria
1.	Drinking Water Source without conventional treatment but after disinfection	A	1. Total Coliform organism MPN / 100 ml shall be 50 or less 2. pH between 6.5 and 8.5 3. Dissolved Oxygen 6 mg/l or more 4. Biochemical Oxygen Demand 5 days 20°C, 2 mg/l or less
2.	Outdoor bathing (organized)	B	1. Total Coliform organism MPN / 100 ml shall be 500 or less 2. pH between 6.5 and 8.5 3. Dissolved Oxygen 5 mg/l or more 4. Biochemical Oxygen Demand 5 days 20°C, 3 mg/l or less

S.No.	Designated best use	Class	Criteria
3.	Drinking water source after conventional treatment and disinfection	C	1. Total Coliform organism MPN / 100 ml shall be 5000 or less 2. pH between 6 and 9 3. Dissolved Oxygen 4 mg/l or more 4. Biochemical Oxygen Demand 5 days 20°C, 3 mg/l or less
4.	Propagation of wild life and fisheries	D	1. pH between 6.5 and 8.5 2. Dissolved Oxygen 4 mg/l or more 3. Free ammonia (as N) 1.2 mg/l or less
5.	Irrigation, industrial cooling, controlled waste disposal	E	1. pH between 6.5 and 8.5 2. Electrical Conductivity at 25°C micro mhos /cm Max. 2250 3. Sodium absorption ratio max 26 4. Boron max. 2 mg/l

The water quality criteria developed for raw waters used for organized community supplies is being reworked by the Central Pollution Control Board. The proposed criterion for the organized community supplied is given at **Table 2.2**

**Table 2.2: General Quality Criteria for Raw water for organized Community Water Supplies (Surface and Ground Water)**

**A. Primary Parameters (frequency of monitoring may be daily or even continuous using even automatic for few parameters like pH, DO and Conductivity)**

S.No.	Parameters	Range / Limiting Value of Water Quality			Note
		High	Medium	Poor	
1.	pH	6.5 – 8.5	6 – 9	6 – 9	To ensure prevention of corrosion in treatment plant and distribution system and interference in coagulation and chlorination
2.	Colour, Pt Scale, Hz units	< 10	< 50	< 500	Colour may not get totally removed during treatment
3.	Total Suspended	<1000	< 1500	< 2000	High suspended solids may increase the cost of

S.No.	Parameters	Range / Limiting Value of Water Quality			Note
		High	Medium	Poor	
	Solids, mg/l				treatment
4.	Odour dilution factor	< 3	< 10	< 20	May not be easily tackled during treatment to render water acceptable
5.	Nitrate, mg/l	< 50	< 50	< 50	High nitrate / nitrite may cause methamoglobinemia
6.	Sulphates, mg/l	< 150	< 250	< 250	May cause digestive abnormality on prolonged consumption
7.	Chloride, mg/l	< 200	< 300	< 400	May cause physiological impact and unpalatable mineral taste.
8.	Fluoride, mg/l	< 1	< 1.5	< 1.5	Prolonged consumption of water containing high fluoride may cause fluorosis.
9.	Surfactants, mg/l	< 0.2	< 0.2	< 0.2	May impair treatability and cause foaming.
10.	Phosphates, mg/l	< 0.4	< 0.7	< 0.7	May interfere with coagulation.
11.	DO (% saturation)	60 - 110	80 - 120	90 - 140	May imply with higher chlorine demand.
12.	Biochemical oxygen demand, mg/l	< 3	< 5	< 7	Could cause problems in treatment, larger chlorine demands and residual taste and odour problem
13.	Total Kjeldahl Nitrogen, mg/l	< 1	< 2	< 3	Same as above
14.	Ammonia, mg/l	< 0.05	< 1	< 2	Same as above
15.	Total Coliform MPN / 100 ml	< 500	< 5000	< 50000	The criteria would be satisfied if during a period not more than 5% samples show greater than 50000 MPN/100 ml, and not more than 20% of samples show greater than prescribed limit.

S.No.	Parameters	Range / Limiting Value of Water Quality			Note
		High	Medium	Poor	
16.	Faecal Coliform, MPN/100 ml	<200	<2000	< 20000	The criteria would be satisfied if during a period not more than 5% samples show greater than 20000 MPN/100 ml, and not more than 20% of samples show greater than prescribed limit.
17.	Faecal Streptococci	200	1000	10000	Same as above

**Note:** There should not be any visible discharge in the upstream (up to 5 kms) of the water intake point

- 1) High Quality Water : Raw water simple disinfections
- 2) Medium Quality Water : Normal Conventional treatment i.e. pre-chlorination, coagulation, flocculation, settling, filtration and disinfections
- 3) Poor Quality of Water: Intensive physical and chemical treatment i.e chlorination, aeration, chemical precipitation, coagulation, flocculation, settling, filtration, adsorption (activated carbon), disinfections, epidemiological surveys needs to be carried out frequently to ensure that the supplied water quality is not resulting in any health problems.

#### **B. Additional Parameters for periodic (say monthly/ seasonal) monitoring**

S.No.	Parameters	Range / Limiting Value of Water Quality			Note
		High	Medium	Poor	
1.	Dissolved iron, mg/l	< 0.3	< 1	< 1	Higher Iron affects the taste of beverages and causes stains.
2.	Copper, mg/l	< 1	< 1	< 1	May result in damage of liver.
3.	Zinc, mg/l	< 5	< 5	< 5	May cause bitter stringent taste.
4.	Arsenic, mg/l	< 0.01	< 0.05	< 0.05	Can cause hyperkeratosis and skin cancer in human beings.

S.No.	Parameters	Range / Limiting Value of Water Quality			Note
		High	Medium	Poor	
5.	Cadmium, mg/l	< 0.001	< 0.005	< 0.005	Toxic to man.
6.	Total-Cr mg/l	< 0.05	< 0.05	< 0.05	Toxic at high doses
7.	Lead, mg/l	< 0.05	< 0.05	< 0.05	Irreversible damage to the brain in children, anaemia, neurological dysfunction and renal impairment.
8.	Selenium, mg/l	< 0.01	< 0.01	< 0.01	Toxic symptoms similar to arsenic.
9.	Mercury, mg/l	< 0.0005	< 0.0005	< 0.0005	Deadly poisonous and carcinogenic.
10.	Phenols, mg/l	< 0.001	< 0.001	< 0.001	Toxic and carcinogenic; may also cause major problem of taste and odour.
11.	Cyanides mg/l	< 0.05	< 0.05	< 0.05	Larger consumption may lead to physiological abnormality.
12.	Polycyclic aromatic hydrocarbons, mg/l	< 0.0002	< 0.0002	< 0.002	Carcinogenic.
13.	Total Pesticides, mg/l	< 0.001	0.0025	< 0.0025	Tend to bio accumulation and bio magnify in the environment , toxic

### C. Quality criteria for water of mass bathing

SI.No	Parameter	Desirable	Acceptable	Note
1.	Total coliform MPN/100ml	< 500	< 5000	If MPN is noticed to be more than 500 / 100 ml, then regular tests should be carried out. The criteria would be satisfied if during a period not more than 5% samples show greater than 10000 MPN/100 ml and

				not more than 20% of samples show greater than 5000 ml.
2.	Faecal Coliform MPN/100 ml	< 100	<1000	If MPN is noticed to be more than 100 / 100 ml, then regular tests should be carried out. The criteria would be satisfied if during a period not more than 5% samples show greater than 5000 MPN/100 ml and not more than 20% of samples show greater than 1000/100 ml.
3.	Faecal streptococci MPN/100 ml	< 100	< 1000	Same as above
4.	pH	6 – 9	6 – 9	
5.	Colour	No abnormal colour		
6.	Mineral oil, mg/l	No film visible, < 0.3	No film visible	
7.	Surface active substances, mg/l	< 0.3	-	Skin problem likely
8.	Phenols, mg/l	< 0.005	-	Skin problem and odour problem
9.	Transparency (Sechhi depth)	> 2m	> 0.5m	
10.	BOD, mg/l	< 5	-	High organic matter may be associated with coliform / pathogens.
11.	Dissolved oxygen (% saturation)	80 – 120	-	May be associated with coliform / pathogens.
12.	Floating matter of any type	Absent	Absent	

**Note:** No direct or indirect visible discharge of untreated domestic / industrial Wastewater

**D. Water quality criteria for irrigation- waters (for selected suitable soil-crop combinational only)**

<b>Sl. No</b>	<b>Parameter</b>	<b>General</b>	<b>Relaxation for special planned (exceptional notified cases)</b>	<b>Note</b>
1.	Conductivity, $\mu$ mohs / cm	< 2250	< 4000	The irrigation water having conductivity more than 2250 $\mu$ mhos / cm at 25 °C may reduce vegetative growth and yield of the crops. It may also increase soil salinity, which may affect its fertility.
2.	Total Coliform, MPN/100 ml	< 10000	-	No limit for irrigating crops not eaten raw
3.	Faecal Coliform, MPN/100 ml	< 5000	-	No limit for irrigating crops not eaten raw
4.	Faecal streptococci, MPN/100 ml	< 1000	-	No limit for irrigating crops not eaten raw
5.	pH	6 – 9	-	Soil characteristics are important.
6.	BOD, mg/l	< 100	-	Land can adsorb organic matter faster than water.
7.	Floating materials such as wood, plastic, rubber etc.	Absent	-	May inhibit water percolation
8.	Boron	< 2	-	Boron is an essential nutrient for plant growth, however, it becomes toxic beyond 2 mg/l.

Sl. No	Parameter	General	Relaxation for special planned (exceptional notified cases)	Note
9.	SAR	< 26	-	SAR beyond 26 may cause salinity and sodicity in the soil. When it exceeds the limit, method of irrigation and salt tolerance of crops should be kept in mind.
10.	Total heavy metals	< 0.5 mg/l	< 5 mg/l	-

## 2.2 Significance of Anions and Cations in Natural Water

The principal constituents of ionic species and their distribution in natural waters vary greatly depending on the geographical formations and soil type. Important ionic species (Cation & Anion) in all natural waters that influence water quality and represent the principal chemical constituents, which are listed below:

### Cation

Calcium ( $\text{Ca}^{2+}$ )  
Magnesium ( $\text{Mg}^{2+}$ )  
Sodium ( $\text{Na}^+$ )  
Potassium ( $\text{K}^+$ )  
Iron ( $\text{Fe}^{2+}$ )  
Manganese ( $\text{Mn}^{2+}$ )

### Anions

Bicarbonate ( $\text{HCO}_3^-$ ) and  
Carbonate ( $\text{CO}_3^{2-}$ )  
Chloride ( $\text{Cl}^-$ )  
Sulfate ( $\text{SO}_4^{2-}$ )  
Nitrate ( $\text{NO}_3^-$ )  
Phosphate ( $\text{PO}_4^{3-}$ )  
Fluoride ( $\text{F}^-$ )

**Calcium:** It is derived mostly from rocks, and maximum concentrations come from lime stone, dolomite, gypsum, and gypsiferous shale. Calcium is the second major constituent, after bicarbonate, present in most natural waters, with a concentration range between 10 and 100 mg/l. Calcium is a primary constituent of water hardness and calcium level between 40 and 100 mg/l are generally considered as hard to very hard.



**Magnesium:** Source of magnesium includes ferromagnesium minerals in igneous and metamorphic rocks and magnesium carbonate in limestone and dolomite. Magnesium salts are more soluble than calcium, but they are less abundant in geological formations. At high concentration in drinking water, magnesium salts may have laxative effects. They may also cause unpleasant taste at concentrations above 500 mg/l. For irrigation purposes, magnesium is a necessary plant nutrient as well as a necessary soil conditioner. Magnesium is associated with hardness of water, and is undesirable, in several industrial processes.

**Sodium:** The major source of sodium in natural waters is from weathering of feldspars, evaporates, and clay. Sodium salts are very soluble and remain in solution. Typical sodium concentrations in natural waters range between 5 and 50 mg/l. Excessive sodium intake is linked to hypertension in humans. A deficiency may result in hyponatremia and muscle fatigue. The recommended USEPA limit of sodium in drinking water supply is 20 mg/l.

**Potassium:** Potassium is less abundant than sodium in natural waters. Its concentration rarely exceeds 10 mg/l in natural waters. In highly cultivated areas, runoff may contribute to temporarily high concentrations as plants take up potassium and release it on decay. From the point of view of domestic water supply, potassium is of little importance and creates no adverse effects. There is presently no recommended limit in drinking water supply.

**Iron:** Iron is present in soils and rocks as ferric oxides ( $\text{Fe}_2\text{O}_3$ ) and ferric hydroxides  $[\text{Fe}(\text{OH})_3]$ . In natural waters, iron may be present as ferrous bicarbonate  $[\text{Fe}(\text{HCO}_3)_2]$ , ferrous hydroxide, ferrous sulfate ( $\text{FeSO}_4$ ), and organic (chelated) iron. The USEPA secondary drinking water regulations limit for iron is 0.3 mg/l, for reasons of aesthetics and taste.

**Manganese:** Manganese is present in rocks and soils. In natural waters, it appears with iron. Common manganese compounds in natural waters are manganous bicarbonate  $[\text{Mn}(\text{HCO}_3)_2]$ , manganous chloride ( $\text{MnCl}_2$ ), and manganous sulfate ( $\text{MnSO}_4$ ). The toxicity of Mn may include neurobehavioral

changes. The USEPA secondary standard for aesthetic reasons for Mn is 0.05 mg/l.

**Bicarbonate – Carbonate:** Bicarbonate is the major constituent of natural water. It comes from the action of water containing carbon dioxide on limestone, marble, chalk, calcite, dolomite, and other minerals containing calcium and magnesium carbonate. The carbonate-bicarbonate system in natural waters controls the pH and the natural buffer system. The typical concentration of bicarbonate in surface waters is less than 200 mg/l as  $\text{HCO}_3$ . In groundwater, the bicarbonate concentration is significantly higher.

**Chloride:** Chloride in natural waters is derived from chloride-rich sedimentary rock. In typical surface waters, the chloride concentration is less than 10 mg/l.

Drinking water standards have been formulated and updated time to time, as more and more knowledge about effect of various parameters in drinking water is acquired. Drinking water standards formulated by Bureau of Indian Standards (BIS) and also guidelines of Central Public Health and Environmental Engineering Organization (CPHEEO), as recommended by the World Health Organization (WHO) are given at **Annexure 4** and **Annexure 5** respectively.

### 2.3 Per Capita Water Supply in India

Per Capita Water Supply per day is arrived normally including the following components:

- Domestic needs such as drinking, cooking, bathing, washing, flushing of toilets, gardening and individual air cooling.
- Institutional needs
- Public purposes such as street washing or street watering, flushing of sewers, watering of public parks.
- Minor industrial and commercial uses
- Fire fighting
- Requirements of live stock and
- Minimum permissible Unaccounted for Water (UFW)

Water supply levels in liters per capita per day (lpcd) for domestic & non domestic purpose and Institutional needs, as recommended by CPHEEO for designing water treatment schemes are given at **Table 2.3**. The water requirements for institutions should be provided in addition to the provisions indicated for domestic and non-domestic, where required, if they are of considerable magnitude and not covered in the provisions already made.

**Table 2.3: Per Capita Water Supply Levels for Design of Scheme**

<b>S.No.</b>	<b>Classification of Towns / Cities</b>	<b>LPCD</b>
<b>A.</b>	<b>Domestic &amp; Non- Domestic Needs</b>	
1.	Towns provided with piped water supply but without sewerage system	70
2.	Cities provided with piped water supply sewerage system is existing / contemplated	135
3.	Metropolitan and Mega cities provided with piped water supply where sewerage system is existing/contemplated	150
<b>B.</b>	<b>Institutional Needs</b>	
1.	Hospital (including laundry)	
	a) No. of beds exceeding 100	450 / bed
	b) No. of beds not exceeding 100	340 / bed
2.	Hotels	180 / bed
3.	Hostels	135
4.	Nurses home and medical quarters	135
5.	Boarding schools / colleges	135
6.	Restaurants	70 / seat
7.	Air ports and sea ports	70
8.	Junction Stations and intermediate stations where mail or express stoppage (both railways and bus stations)	70
9.	Terminal stations	45
10.	Intermediate stations (excluding mail and express stop) (Could be reduced to 25 where no bathing facilities)	45
11.	Day schools / colleges	45
12.	Offices	45
13.	Factories(could be reduced to 30 where no bathrooms)	45
14.	Cinema, concert halls and theatre	15

**Note:**

- In Urban areas, where water is provided through public stand posts, 40 lpcd should be considered.
- Figures exclude “Unaccounted for Water (UFW)” which should be limited to 15%.
- Figures include requirements of water for commercial, institutional and minor industries. However, the bulk supply to such establishments should be assessed separately with proper justification.

One of the working groups of the National Commission for Integrated Water Resources Development Plan on the Perspective of Water Requirements also deliberated regarding the norms for urban and rural water supply. In their view, a variety of factors affect water use in rural and urban areas. These include population size of habitat, economic status, commercial and manufacturing activities. A host of other factors like climate, quality of life, technology, costs, conservation needs etc. also influence these requirements. Desirable and feasible norms can be established by reviewing past performance and modifying these on the basis of equity and sustainability. Since fresh water resources are very unevenly distributed around the world, it is not surprising that the per capita water supply also varies widely ranging from 50 lpcd to 800 lpcd. Keeping in view the above factors, the Working Group of the National Commission for integrated Water Resources Development Plan, as a final goal, has suggested the norms for water supply as 220 lpcd for urban areas and 150 lpcd for rural areas.

Central Pollution Control Board reviewed, as per the water supply status of year 1995, the total water supply in Class I cities was 20545 mld and per capita water supply was 182 litres. In case of Class II cities, the total water supply was 1936 mld and per capita water supply was 103 liters. Per capita water supply for metropolitan cities estimated based on the information obtained are given at **Table 2.4**. Also per capita water supply variations in different states are summarized at **Table 2.5**. It is observed that a minimum and maximum per capita water supply figure is reported for Kerala state as 12 lpcd and 372 lpcd.

**Table 2.4: Per Capita Water Supply for Metropolitan Cities**

S.No.	Name of city	Population *	WTP Installed capacity (MLD)	LPCD
1.	Bangalore	6523110	900	138
2.	Chennai	4216268	573.8	136
3.	Delhi	13782976	2118	154
4.	Hyderabad	3686460	668	181
5.	Kolkata	11021918	909	83
6.	Mumbai	11914398	3128	263

**Note:** \* - as on 2001

**Table 2.5: Per Capita Water Supply at various States of India**

S.No.	State / Union Territory	Water Supply (lpcd)	
		Min.	Max.
1.	Andhra Pradesh	41	131
2.	Assam	77	200
3.	Gujrat	21	157
4.	Karnataka	45	229
5.	Kerala	12	372
6.	Madhya Pradesh	28	152
7.	Mizoram	26	280
8.	Maharashtra	32	291
9.	Haryana	30	105
10.	Punjab	42	268
11.	Tamil Nadu	51	106
12.	Uttar Pradesh	63	172
13.	West Bengal	66	237

## 2.4 Scarcity of Water

Unplanned / unprecedented growth of the city activities dwells population thereby some areas of the city experience water scarcity. However, primarily the following four reasons can be attributed to this water scarcity:

1. Population increase and consequent increase in water demand.
2. All near by water sources have been tapped or being tapped and hence the future projects will be much more expensive.
3. Increasing social and environmental awareness delay project implementation time.
4. Increase in developmental activities such as urbanization and industrialization lead to generation of more and more wastewater which contaminates the available sources of fresh water.

Due to the tremendous pressure on water requirement leads to over exploitation of nearby traditional water sources, particularly in case of large cities, thus many cities fall under the crisis sooner or later. Cities, therefore, have to reach out for sources that are far away and very expensive to develop and convey. A few examples are given below:

<b>Name of cities</b>	<b>Raw Water Sources</b>	<b>Distance (Km)</b>
1. Ahmedabad	• River Sabarmati (Dharoi Dam)	150
2. Bangalore	• River Cauvery (K.R.Sagar)	100
3. Chennai	• River Krishna (Telugu Ganga)	400
4. Delhi	• River Bhagirathi (Tehri Dam)	250
	• Renuka Dam (Planning Stage)	280
	• Kishau Dam (Planning Stage)	300
5. Hyderabad	• River Krishna (Nagarjunasagar)	160
6. Mumbai	• Bhasta Dam	54

## **2.5 Water Conservation**

Some of the strategies needed for water conservation are outlined in the following paragraphs:

### **A. Unaccounted for Water (UFW)**

It has been assessed that the Unaccounted for water (UFW) through leakage and wastage in Indian cities ranges anywhere between (20-40%) and more than 80% of this occurs in the distribution system and consumer ends.

Leaving aside the unavoidable water losses, even if 10% of the leakage losses are conserved, then it would be possible to save about Rs. 550 crores per year by way of reduction in production cost. Thus, there is an urgent need for periodic leak detection and control measures to conserve the valuable treated water, which will not only help to augment the supply levels, but also increase the revenue and reduce pollution load. The urban local bodies especially in the bigger cities and towns may give importance for developing action plans, such as creation of leak detection cells, periodical survey and identification of leaks, repair of leakage etc. for water conservation.

### **B. Options for Reduction wastage of water**

- Identify and authorize illegal connections.
- Wherever feasible install water meters, more so far bulk supplies and establishing meter repair workshop to repair defective meters.
- Renovate old and dilapidated pipelines in the distribution system since major portion of the leakage is found in the distribution system and premises.
- Carryout leak detection and preventive maintenance to reduce leakage and unaccounted for water in the system.

### **C. Pricing of Water Supply**

It has been universally acknowledged that adequate attention has not been paid to pricing of water in the developing countries. Since the provision of water for drinking and domestic uses is a basic need, the pricing of water for this purpose is subsidized. It has been assessed through extensive studies that the rich people are paying less for the quantum of water they consume compared to the poor. Therefore, the objectives of pricing policy consider the following,

keeping in view the crucial role played by water pricing policy, in providing incentives for efficient use and conservation of the scarce resource:

- Determine the water charges (water tariff) based on the average incremental cost of production & supply of water in a water supply system and implement the same in the city by enacting suitable byelaws.
- Wherever no meter supply is effective, a flat rate may be levied based on the average cost of production and supply of water.
- Impose progressive water rates upon the consumers. For welfare of the urban poor, water may be supplied to them at a subsidized rate. However, minimum charge may be collected from them at a flat rate, instead of free supply so that they can realize the importance of treated water supply. But charge the affluent sections of the society at a higher rate based on metered quantity including free supply, if the consumption is more than the prescribed limit.
- Water charges may be revised upwards such that these reflect the social cost of the water use. Introduce pollution tax may addresses the issues in water conservation and environmental protection.
- Where metering is not possible, flat-water charges could be linked as percentage of property tax.
- All expenditure incurred may be recovered through tax in order to make the water utility self-supporting. Besides, funds for future expansion may be created so as to minimize dependence on outside capital. Distribution of costs equitably amongst water users may be adopted.
- Avoid undue discrimination to subsidize particular users as a principle of redistribution of income and to ensure that even the poorest members of the community are not deprived access to safe water.
- Subsidize a minimum level of service on public health grounds. Discourage wastage and extravagant use of water and to encourage user economy by designing the tariff with multi-tier system incorporating incentives for low consumption.



## **D. Recycle and Reuse**

In India, reuse and recycling of treated sewage is considered important on account of two advantages (1) Reduction of pollution in receiving water bodies and (2) Reduction in fresh water requirement for various uses.

Reuse of treated sewage after necessary treatment of meet industrial water requirements has been in practice for quite some time in India. In some multi story buildings, the sewage is treated in the basement itself and reused as make up water in the building's air-conditioning system. A couple of major industries in and around Chennai & Mumbai have been using treated sewage for various non-potable purposes. In Chandigarh, about 45 MLD of sewage is given tertiary treatment and then used for horticulture, watering of lawns etc. In Chennai, it is contemplated to treat 100 MLD up to tertiary level and use the same in major industries.

## **E. Rainwater Harvesting**

Rainwater harvesting (RWH) refers to collection of rain falling on earth surfaces for beneficial uses before it drains away as run-off. The concept of RWH has a long history. Evidences indicate domestic RWH having been used in the Middle East for about 3000 years and in other parts of Asia for at least 2000 years. Collection and storage of rainwater in earthen tanks for domestic and agricultural use is very common in India since historical times. The traditional knowledge and practice of RWH has largely been abandoned in many parts of India after the implementation of dam and irrigation projects. However, since the early 90s, there has been a renewed interest in RWH projects in India and elsewhere.

Rainwater harvesting can be done at individual household level and at community level in both urban as well as rural areas. At household level, harvesting can be done through roof catchments, and at community level through ground catchments. Depending on the quantity, location and the intended use, harvested rainwater, it can be utilized immediately or after storage. Other than as a water supply, RWH can be practiced with the objectives of flood control and soil erosion control and ground water recharging.

## **3.0 WATER TREATMENT TECHNOLOGIES**

### **3.1 Purpose**

Three basic purpose of Water Treatment Plant are as follows:

- I. To produce water that is safe for human consumption
- II. To produce water that is appealing to the consumer
- III. To produce water - using facilities which can be constructed and operated at a reasonable cost

Production of biologically and chemically safe water is the primary goal in the design of water treatment plants; anything less is unacceptable. A properly designed plant is not only a requirement to guarantee safe drinking water, but also skillful and alert plant operation and attention to the sanitary requirements of the source of supply and the distribution system are equally important. The second basic objective of water treatment is the production of water that is appealing to the consumer. Ideally, appealing water is one that is clear and colorless, pleasant to the taste, odorless, and cool. It is none staining, neither corrosive nor scale forming, and reasonably soft.

The consumer is principally interested in the quality of water delivered at the tap, not the quality at the treatment plant. Therefore, water utility operations should be such that quality is not impaired during transmission, storage and distribution to the consumer. Storage and distribution system should be designed and operated to prevent biological growths, corrosion, and contamination by cross-connections. In the design and operation of both treatment plant and distribution system, the control point for the determination of water quality should be the customer's tap.

The third basic objective of water treatment is that water treatment may be accomplished using facilities with reasonable capital and operating costs. Various alternatives in plant design should be evaluated for production of cost effective quality water. Alternative plant designs developed should be based upon sound engineering principles and flexible to future conditions, emergency situations, operating personnel capabilities and future expansion.

### **3.2 Surface Water Treatment System**

The sequence of water treatment units in a water treatment plant mostly remains same, as the principle objectives are to remove turbidity and

disinfection to kill pathogens. The first treatment unit in a water treatment plant is aeration, where water is brought in contact with atmospheric air to fresh surface water and also oxidizes some of the compounds, if necessary. Many Water Treatment Plants do not have aeration system. The next unit is chemical addition or flash mixer where coagulant (mostly alum) is thoroughly mixed with raw water by way of which neutralization of charge of particles (coagulation) occurs.

This water is then flocculated i.e bigger floc formation is encouraged which enhances settlement. The flocculated water is then taken to sedimentation tanks / clarifiers for removal of flocs and from there to filters where remaining turbidity is removed. The filtered water is then disinfected, mostly with chlorine and then stored in clear water reservoirs from where it is taken to water distribution system. Commonly used unit operations and unit processes as described above are given in **Table 3.1**. Sludge from clarifiers and filter backwash water are generally discharged into the nearby drain, however, there is a trend now to reuse / treat these wastes.

**Table 3.1: Unit Operations and Unit Process of Water Treatment Units**

S.No.	Units	UO (or) UP	Principle Applications
1.	Micro strainer	UO	Remove algae and plankton from the raw water
2.	Aeration	UP	Strips and oxidizes taste and odour causing volatile organics and gases and oxidizes iron and manganese. Aeration systems include gravity aerator, spray aerator, diffuser and mechanical aerator.
3.	Mixing	UO	Provides uniform and rapid distribution of chemicals and gases into the water.
4.	Pre-oxidation	UP	Application of oxidizing agents such as ozone, potassium permanganate, and chlorine compounds in raw water and in other treatment units; retards microbiological growth and oxidizes taste, odor and colour causing compounds
5.	Coagulation	UP	Coagulation is the addition and rapid mixing of coagulant resulting in destabilization of the colloidal particle and formation of pin-head floc

S.No.	Units	UO (or) UP	Principle Applications
6.	Flocculation	UO	Flocculation is aggregation of destabilized turbidity and colour causing particles to form a rapid-settling floc
7.	Sedimentation	UO	Gravity separation of suspended solids or floc produced in treatment processes. It is used after coagulation and flocculation and chemical precipitation.
8.	Filtration	UO	Removal of particulate matter by percolation through granular media. Filtration media may be single (sand, anthracite, etc.), mixed, or multilayered.
9.	Disinfection	UP	Destroys disease-causing organisms in water supply. Disinfection is achieved by ultraviolet radiation and by oxidative chemicals such as chlorine, bromine, iodine, potassium permanganate, and ozone, chlorine being the most commonly used chemical

**Note:** UO – Unit Operations  
UP – Unit Process

### 3.3 Operation / Process of Water Treatment Units

Each treatment units operation / process is precisely discussed below:

#### 3.3.1 Aeration

Aeration involves bringing air or other gases in contact with water to strip volatile substances from the liquid to the gaseous phase and to dissolve beneficial gases into the water. The volatile substance that may be removed includes dissolved gases, volatile organic compounds, and various aromatic compounds responsible for tastes and odors. Gases that may be dissolved into water include oxygen and carbon dioxide. Purposes of aeration in water treatment are:

- to reduce the concentration of taste and odor causing substances, such as hydrogen sulfide and various organic compounds, by volatilization / stripping or oxidation,
- to oxidize iron and manganese, rendering them insoluble,

- to dissolve a gas in the water (ex. : addition of oxygen to groundwater and addition of carbon dioxide after softening), and
- to remove those compounds that may in some way interfere with or add to the cost of subsequent water treatment (ex.: removal of hydrogen sulfide before chlorination and removal of carbon dioxide prior to softening)

**Types of Aerators:** Four types of aerators are in common use: (i) Gravity aerators, (ii) Spray aerators, (iii) Diffusers, and (iv) Mechanical aerators. A major design consideration for all types of aerators is to provide maximum interface between air and water at a minimum expenditure of energy. A brief description of each type of aerator is provided here.

**Gravity Aerator:** Gravity Aerators utilize weirs, waterfalls, cascades, inclined planes with riffle plates, vertical towers with updraft air, perforated tray towers, or packed towers filled with contact media such as coke or stone. Various type of gravity aerators are shown in **Fig 3.1 (A to D)**

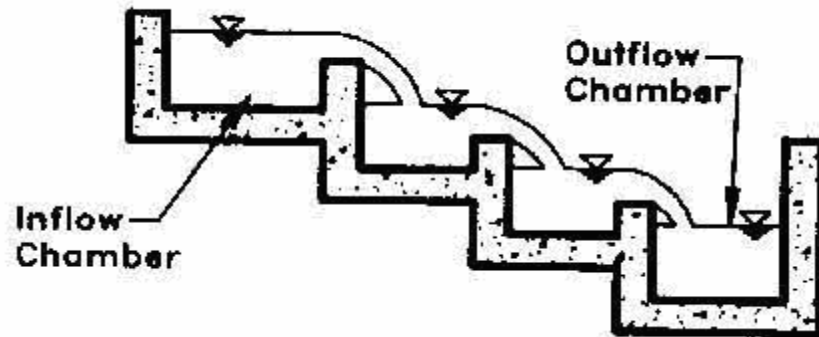

**Fig 3.1 A: Cascade type Gravity Aerator**

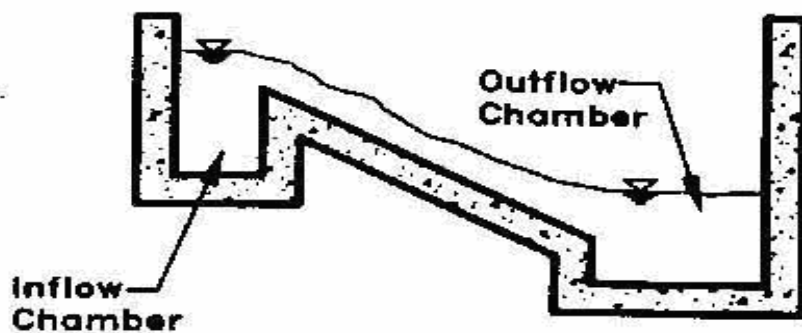

**Fig. 3.1 B: Inclined apron possibly studded with riffle plate**

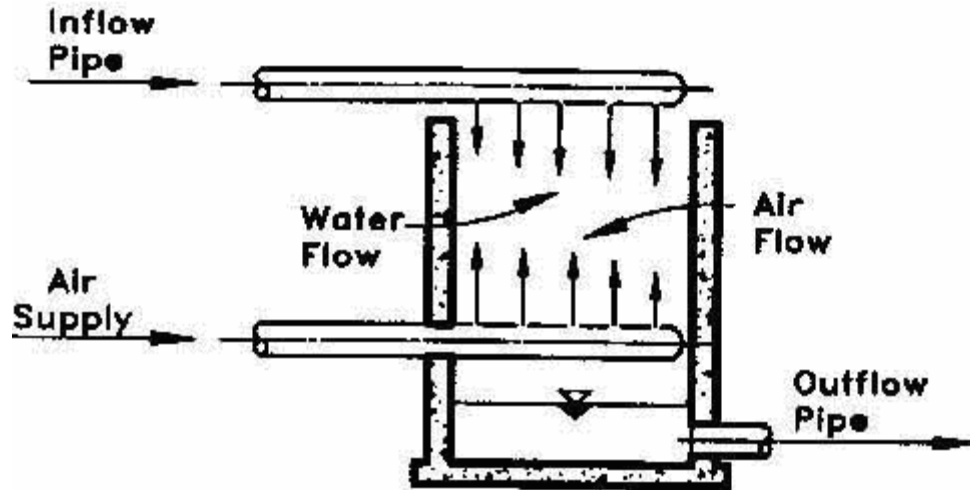

Fig. 3.1 C: Tower with counter current flow of air and water

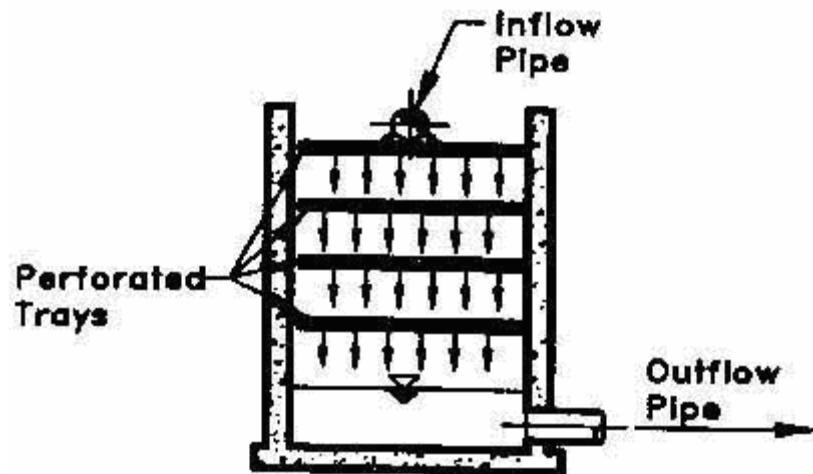

Fig. 3.1 D: Stack of perforated pans possibly contact media

**Spray Aerator:** Spray aerator spray droplets of water into the air from moving or stationary orifice or nozzles. The water raises either vertically or at an angle and falls onto a collecting apron, a contact bed, or a collecting basin. Spray aerators are also designed as decorative fountains. To produce an atomizing jet, a large amount of power is required, and the water must be free of large solids. Losses from wind carryover and freezing in cold climates may cause serious problems. A typical spray aerator is shown in Fig.3.2.

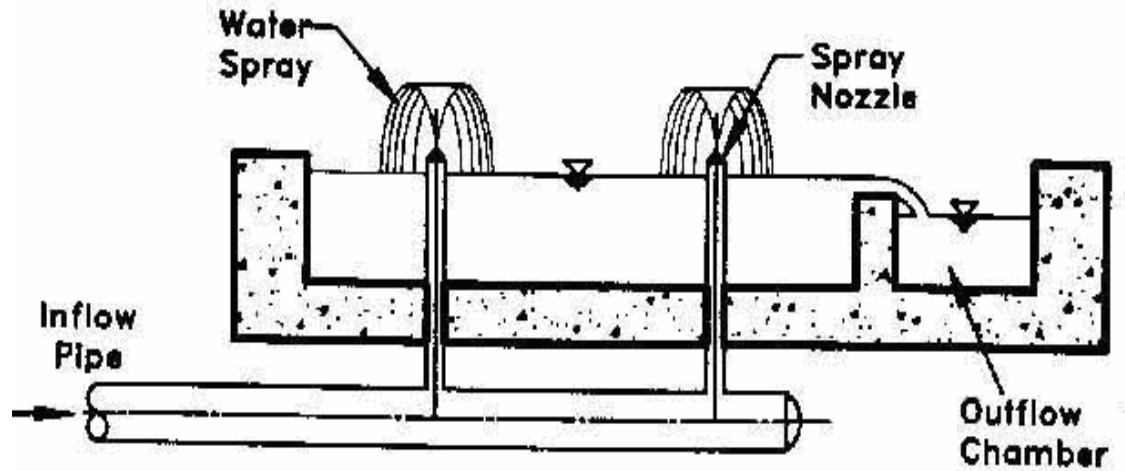

Fig. 3.2: Spray Aerator

**Diffused-Air Aerators:** Water is aerated in large tanks. Compressed air is injected into the tank through porous diffuser plates, or tubes, or spargers. Ascending air bubbles cause turbulence and provide opportunity for exchange of volatile materials between air bubbles and water. Aeration periods vary from 10 to 30 min. Air supply is generally 0.1 to 1 m<sup>3</sup> per min per m<sup>3</sup> of the tank volume. Various type of diffused aeration systems are shown in Fig. 3.3 (A to D).

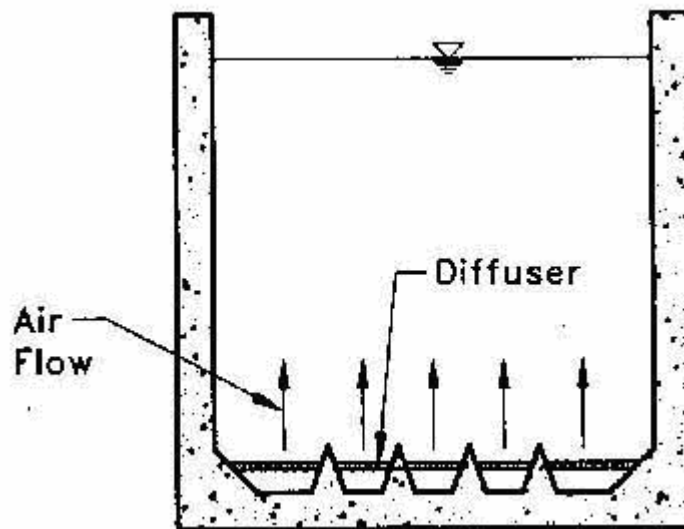

Fig. 3.3 A: Longitudinal Furrows

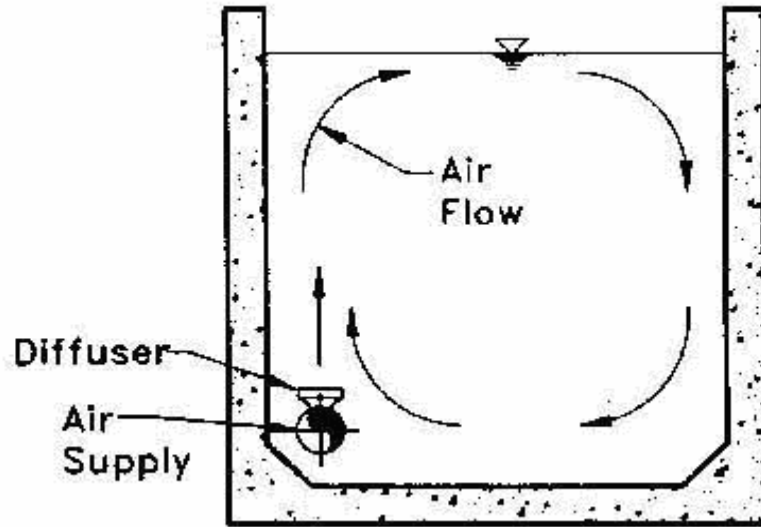

Fig. 3.3 B: Spiral Flow with bottom diffusers

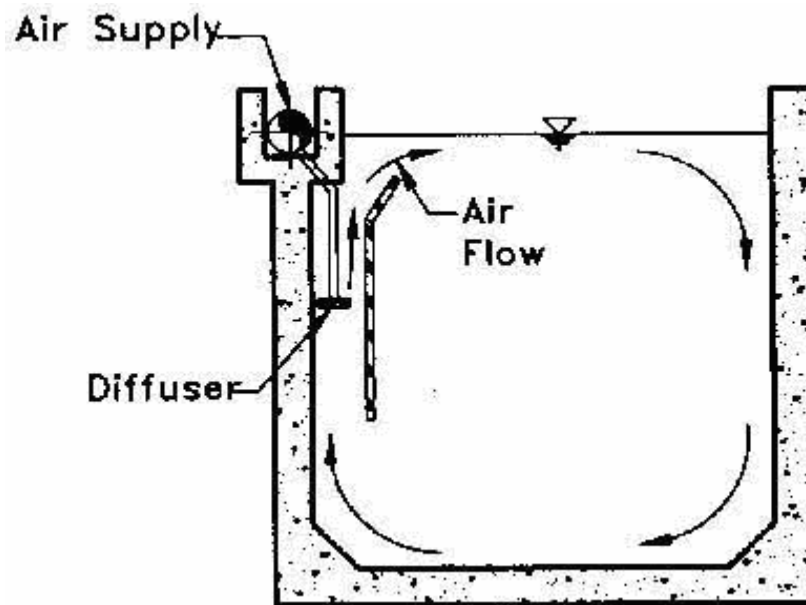

Fig. 3.3 C: Spiral flow with baffle and low depth diffusers



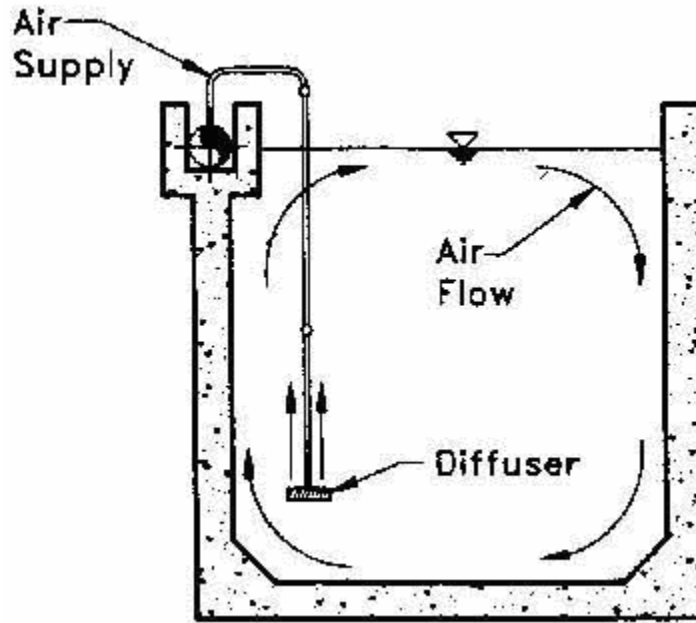

Fig. 3.3 D: Swing diffusers

**Mechanical Aerator:** Mechanical aerators employ either motor driven impellers or a combination of impeller with air injection devices. Common types of devices are submerged paddles, surface paddles, propeller blades, turbine aerators, and draft-tube aerators. Various types of mechanical aerators are shown in Fig 3.4 (A to C).

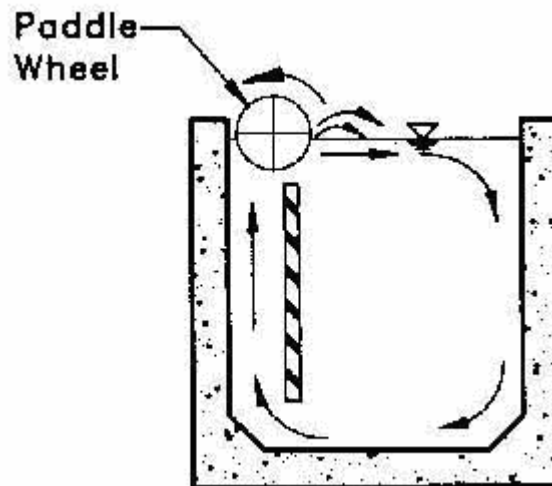
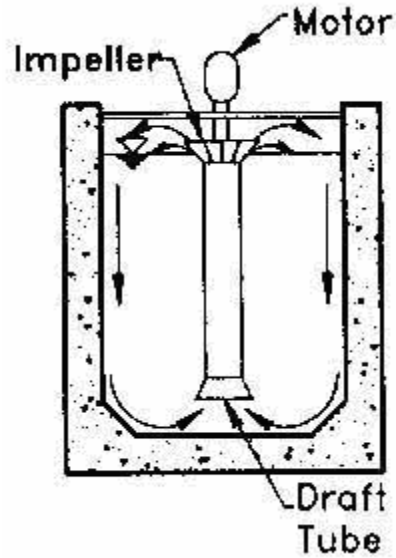
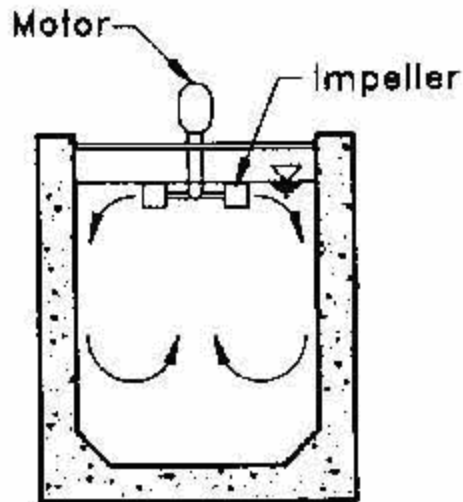

Fig. 3.4 A: Surface Paddles



**Fig. 3.4 B: Draft Tube Turbine Type**



**Fig. 3.4 C: Turbine Aerator**

### **3.3.2 Coagulation and Flocculation**

Coagulation and Flocculation may be broadly described as a chemical / physical process of blending or mixing a coagulating chemical into a stream and then gently stirring the blended mixture. The over all purpose is to improve the particulate size and colloid reduction efficiency of the subsequent settling and or filtration processes. The function and definition of each stage of the process are summarized below:

**Mixing** frequently referred to as flash mixing, rapid mixing, or initial mixing. It is the physical process of blending or dispersing a chemical additive into an unblended stream. Mixing is used where an additive needs to be dispersed rapidly (within a period of 1 to 10 sec).

**Back Mixing** is the dispersion of an additive into a previously blended or partially blended stream or batch. In most cases, back mixing results in less efficient use of chemicals. Back mixing frequently occurs when the volume of the mixing basin or reactor section of a process is too large or the flow rate is low. Back mixing or solids contact may be advantageous to some processes.

**Coagulation** is the process of destabilization of the charge (predominantly negative) on suspended particulates and colloids. The purpose of destabilization is to lessen the repelling character of the particles and allow them to become attached to other particles so that they may be removed in subsequent processes. The particulates in raw water (which contribute to color and turbidity) are mainly clays, silts, viruses, bacteria, fulvic and humic acids, minerals (including asbestos, silicates, silica, and radioactive particles), and organic particulates. At pH levels above 4, such particles or molecules are generally negatively charged.

**Coagulant** chemicals are inorganic and / or organic chemicals that, when added to water at an optimum dose (normally in the range of 1 to 100 mg/l), will cause destabilization. Most coagulants are cationic in water and include water treatment chemicals such as alum, ferric sulfate, lime CaO), and cationic organic polymers.

**Flocculation** is the agglomeration of destabilized particles and colloids toward settleable (or filterable) particles (flocs.). Flocculated particles may be small (less than 0.1 mm diameter) microflocs or large, visible flocs (0.1 to 3.0 mm diameter). Flocculation begins immediately after destabilization in the zone of decaying mixing energy (downstream from the mixer) or as a result of the turbulence of transporting flow. Such incidental flocculation may be an adequate flocculation process in some instances. Normally flocculation involves an intentional and defined process of gentle stirring to enhance contact of destabilized particles and to build floc particles of optimum size, density, and strength to be subsequently removed by settling or filtration.

Coagulation and precipitation processes both require the addition of chemicals to the water stream. The success of these processes depends on rapid and thorough dispersion of the chemicals. The process of dispersing chemicals is known as rapid mix or flash mix. Geometry of the rapid mixer is the most important aspect of its design. The primary concern in the geometric design is

to provide uniform mixing for the water passing through the mixer and to minimize dead areas and short-circuiting.

Rapid mixers utilizing mechanical mixers are usually square in shape and have a depth to width ratio of approx. 2. The size and shape of the mixer impeller should be matched to the desired flow through the mixer. Mixing units with vertical flow patterns utilizing radial-flow mixers tend to minimize short-circuiting effects. **Fig 3.5** illustrates the flow pattern from such a mixer. Round or cylindrical mixing chambers should be avoided for mechanical mixers. A round cross section tends to provide little resistance to rotational flow (induced in the tank by the mixer) resulting in reduced mixing efficiencies. Baffles can be employed to reduce rotational motion and increase efficiencies.

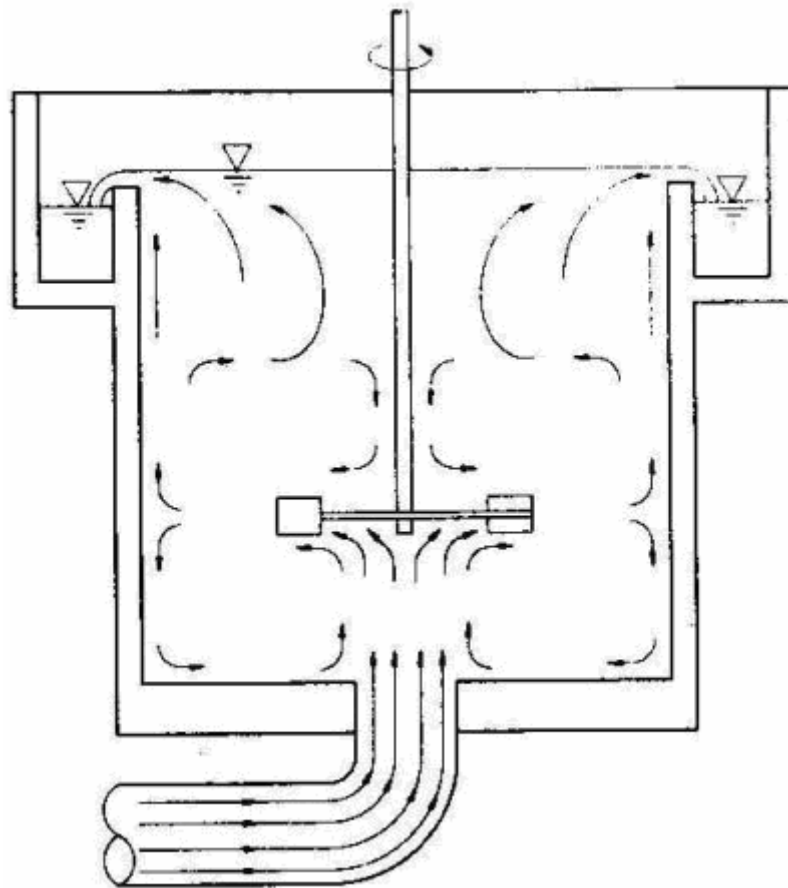

**Fig. 3.5: Flow Pattern in Radial flow Mechanical Mixer Unit**

A channel with fully turbulent flow of sufficient length to yield the desired detention time, followed by a hydraulic jump, has been used successfully. **Fig. 3.6** illustrates a typical rapid mixer utilizing a hydraulic jump.

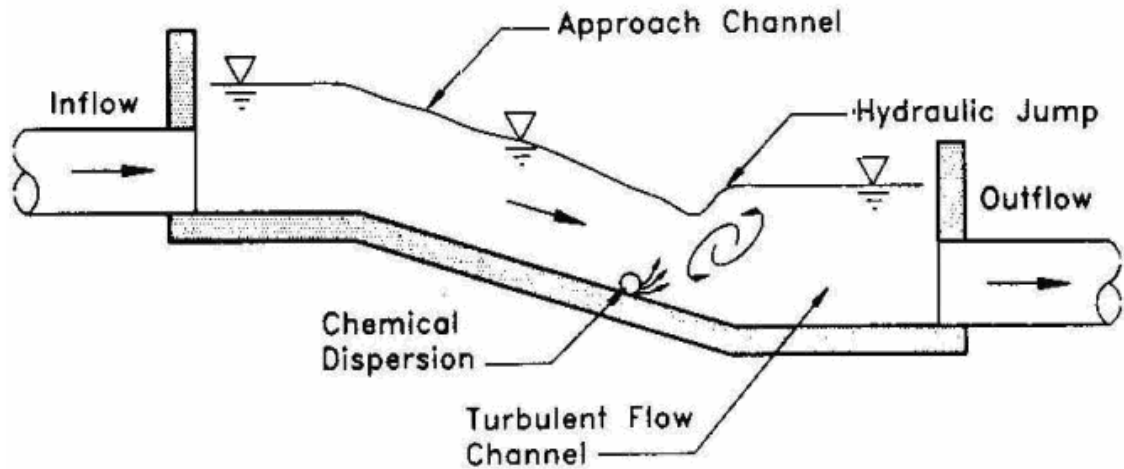

**Fig. 3.6: Rapid Mixer utilizing a Hydraulic Pump**

### 3.3.3 Sedimentation / Clarification

Sedimentation is one of the two principal liquid-solid separation processes used in water treatment, the other being filtration. In most conventional water treatments plants, the majority of the solids removal is accomplished by sedimentation as a means of reducing the load applied to the filters. In some old and small capacity the water treatment plants settling basins constructed as one story horizontal-flow units such as indicated in **Fig. 3.7**. However, large as well as most of the new water treatment plants are using continuous sludge removal equipment.

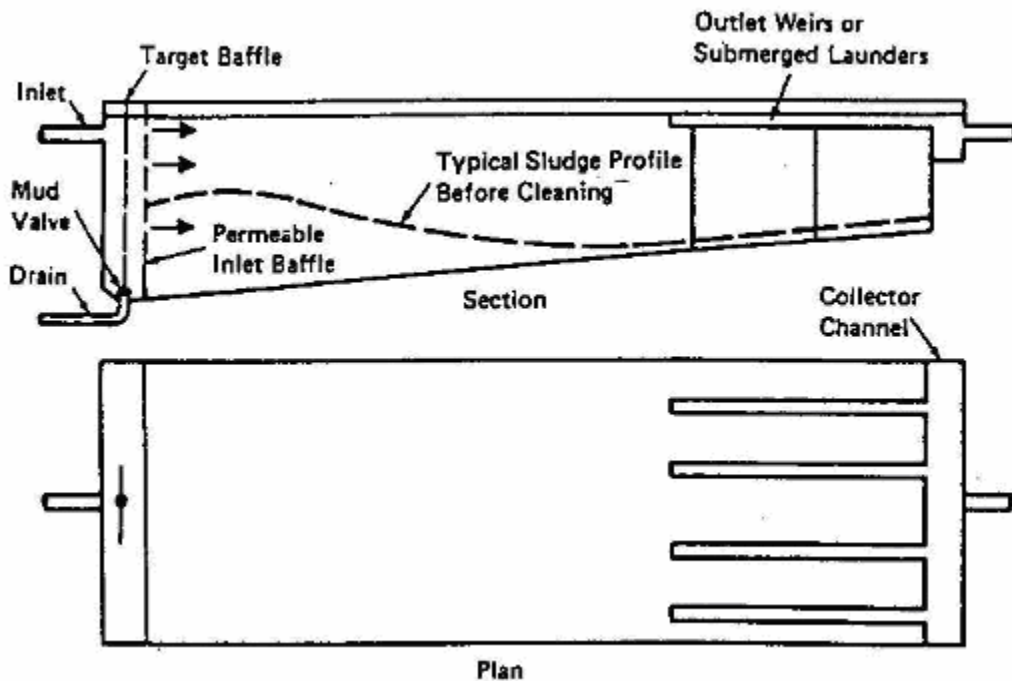
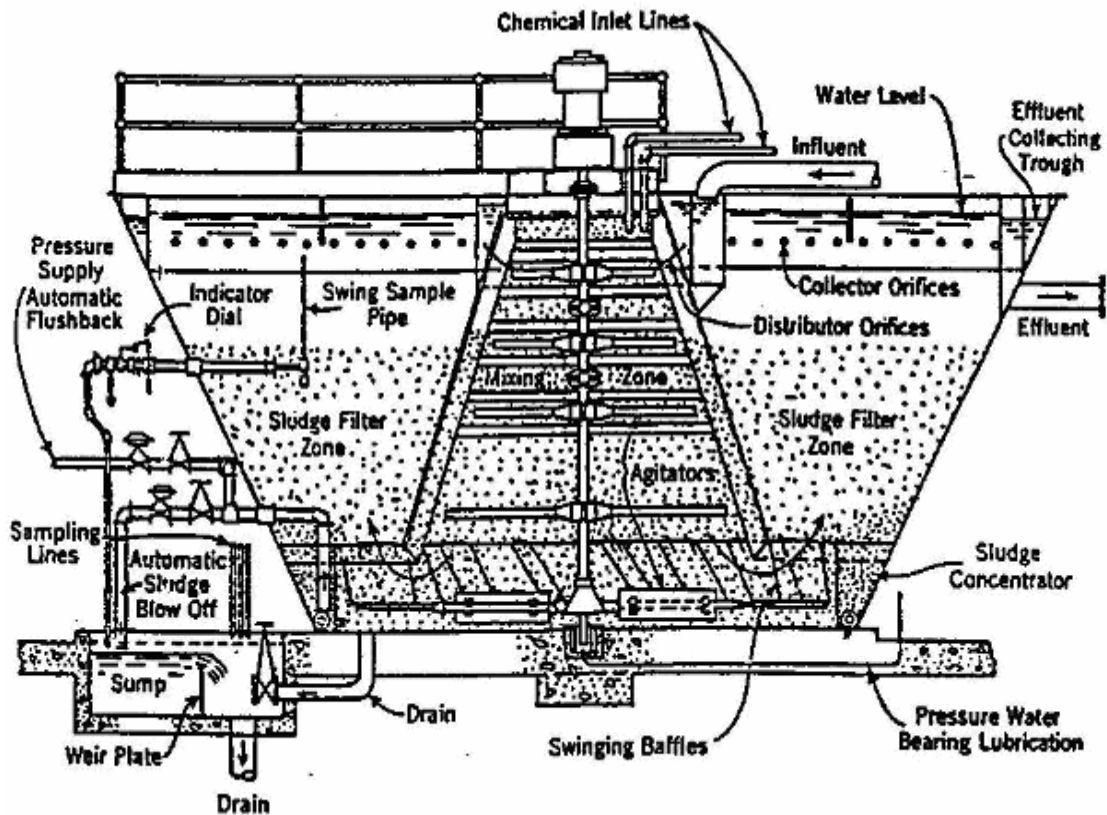

**Fig. 3.7: Conventional Horizontal Flow Settling Basin**

Conventional settling basins have four major zones: (i) the inlet zone; (ii) the settling zone; (iii) the sludge storage or sludge removal zone; (iv) the outlet zone.

There are two general types of circular clarifiers, which are central feed units and rim feed type. A clarifier - flocculator is usually designed as a center feed clarifier, with a mixing mechanism added in the central compartment. Usually these units comprise a single compartment mixer, followed by sedimentation.

**Sludge Blanket Units:** Two different types of sludge-blanket type units. The Spalding precipitator, shown in **Fig. 3.8** includes an agitation zone in the center of the unit, with the water passing upward through a sludge filter zone or sludge blanket. Part of the reaction takes place in the mixing zone, and the balance in the sludge blanket.



**Fig. 3.8: Spalding Precipitator**

The second type Degremont Pulsator is shown in **Fig. 3.9**. The vacuum caused by a pump is interrupted by a water-level-controlled valve at preset time intervals, causing the water in the central compartment to discharge through

the perforated pipe system at high rates in order to attain uniform flow distribution and to agitate the sludge blanket.

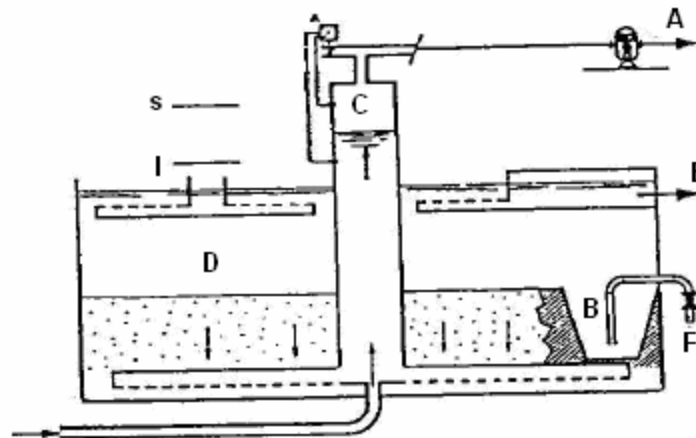

Pulsator Reactor First Half Cycle: Air valve A is closed. The Water rises in the vacuum chamber C. The water in the Clarifier D is at rest. The sludge settles.

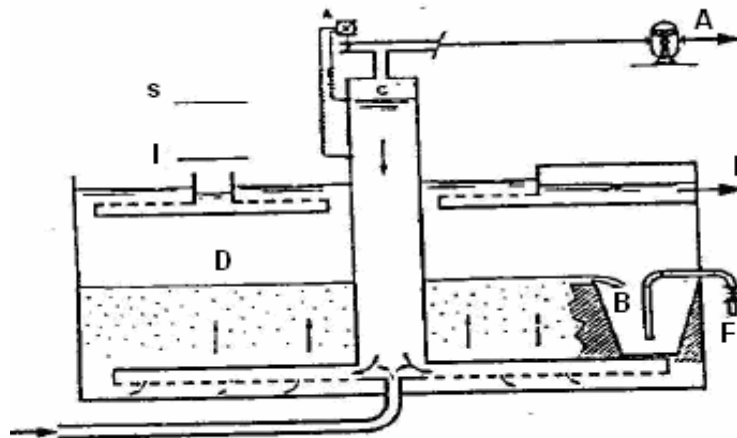

**Fig. 3.9: Degremont Pulsator**

Pulsator Reactor Second Half Cycle: The water in the Vacuum chamber C enters the clarifier D. The sludge in the clarifier rises with the water. The excess sludge enters concentrator B. The clarified water flows off at E. When the water falls to the level I in vacuum chamber C, valve A closes. The compacted sludge in concentration B is evacuated via automatic valve F.

Sludge removal in sludge-blanket units is usually by means of a concentrating chamber into which the sludge at the top of the sludge blanket overflows. Sludge draw-off is regulated by a timer-controlled valve.

**Tube Settlers:** There are two types of settling tubes, horizontal and up flow tube. The horizontal tube consists of clusters of tubes with settling paths of 1 to 2 inch (2.5 cm to 5.1 cm). Properly flocculated material will settle in horizontal tubes in less than 1 min. However, there must be space provided to hold the settled sludge. The actual settling time provided in the tubes is about 10 minutes. After the tubes are full, they are drained and backwashed at the same time as the filter. Total elapsed time in a plant using the horizontal tubes (for mixing, flocculation and sedimentation) is approximately 20-30 minutes.

The up flow tube is placed in either conventional horizontal basins or in upflow basins to improve the sedimentation or to increase the rate of flow through these units. In general, approximately one-third to two-third of the basin area is covered with tubes. In most applications in existing basins, it is not necessary to cover a greater area because of the much higher rise rates permitted with tube settlers. The front part of the basin is used as a stilling area so that the flow reaching the tubes is uniform. The design criteria recommended are typically 2.5 - 5 m / hr. across the total horizontal basin with 3.8 – 7.5 m / hr. through the tube part of the basin. For typical horizontal sedimentation basins, this requires a detention time of 1 - 3 hour. The use of these tubes to increase the flow rate through existing structures (and also for new plants) has been reported.

The up flow tubes can also be used in sludge blanket clarifiers either to increase flow or to improve effluent quality. One positive factor for use of tubes in up flow clarifiers is that settling uniformly into the basin with velocities not greater than 0.5 m / sec. Water from the flocculator to the settling basin must not cascade over a weir, because it destroys the floc. The ideal distribution system is a baffle wall between the flocculator and the settling basin. A stilling zone should be provided between the baffle and the tube zone. In a normal settling basin, it is recommended that not more than two-thirds of the horizontal basin be covered with settling tubes to provide a maximum stilling area ahead of the tubes. However, installations wherein the entire basin area has been covered with tube modules have performed satisfactorily.

### **3.3.4 Filtration**

Filtration is the most relied water treatment process to remove particulate material from water. Coagulation, flocculation, and settling are used to assist the filtration process to function more effectively. The coagulation and settling processes have become so effective that some times filtration may not be necessary. However, where filtration has been avoided, severe losses in water main carrying capacity have occurred as the result of slime formation in the mains. Filtration is still essential.



**Types of Filters:** Commonly used filter types in water treatment are classified on the basis of (a) filtration rate, (b) driving force (c) direction of flow. These are precisely discussed below:

**By Filtration Rate:** Filters can be classified as slow sand filters, rapid filters, or high rate filters depending on the rate of filtration. Slow sand filters have a hydraulic application rate  $<10 \text{ m}^3 / \text{m}^2 / \text{day}$ . This type of filter is utilized extensively in Europe, where natural sand beds along river banks are used as filter medium. Slow sand filters are also used almost exclusively in developing countries. An under drain system exists under the sand bed to collect the filtered water. When the medium becomes clogged, the bed is dewatered, and the upper layer of the sand is removed, washed, and replaced. This type of filter often does not utilize chemical coagulation in the water purification process.

Rapid sand filter have a hydraulic application rate of approximately  $120 \text{ m}^3 / \text{m}^2 / \text{day}$  and high-rate filters have a hydraulic application rate greater than  $240 \text{ m}^3 / \text{m}^2 / \text{day}$  ( $4 \text{ gpm} / \text{ft}^2$ ). Both rapid and high-rate filters are used extensively in the United States. Constructors of these systems are quite similar. Rapid and high rate filters utilize concrete or steel basins filled with suitable filter media. The filter media are supported by a gravel bed and an under drain system, both of which collects the filtered water and distributes the backwash water used to clean the filter bed. There are several types of proprietary filter under drains.

**By Driving Force:** Filters utilized in water treatment are also classified as gravity or pressure filters. The major differences between gravity and pressure filters are the head required to force the water through the media bed and the type of vessel used to contain the filter unit. Gravity filter usually require two to three meters of head and are housed in open concrete or steel tanks. Pressure filters usually require a higher head and are contained in enclosed steel pressure vessels. Because of the cost of constructing large pressure vessels, pressure filters typically are used only on small water purification plants; gravity filters are used on both large and small systems.

**By Direction of Flow:** Filter systems are classified as down flow or up flow. Down flow filters are the most commonly used in water treatment plants. In this type of system, the flow through the media bed is downward. Up flow filtration system, the water flows upward through the media bed, which is rarely used in granular filters (activated carbon) beds.

Water filtration is the only water clarification process that continues to be limited to batch operation. When clogged, the filter medium is cleaned with a washing

operation, then placed back in service and operated until its state of clogging begins to diminish the rate of flow unduly or until quality deteriorates to an unacceptable level, when it is washed again.

### 3.3.5 Backwashing of Filters

As the amount of solids retained in a filter increases, bed porosity decreases. At the same time, head loss through the bed and shear on captured floc increases. Before the head loss builds to an unacceptable level or filter breakthrough begins, backwashing is required to clean the bed.

**Water Source:** Common backwash water source options includes (i) flow bled from high-service discharge and used directly for washing or to fill an above ground wash water tank prior to gravity washing, (ii) gravity flow from above ground finished water storage gravity flow from a separate above ground wash water tank; (iii) direct pumping from a sump or below ground clear well.

**Washing Method:** Three basic washing methods are: up flow water wash without auxiliary scour, up flow water wash with surface wash and up flow water wash with air scour. The application will normally dictate the method to be used. Filter bed expansion during up flow water wash results in media stratification. Air washing results in bed mixing. If stratification is desired, air scour must be avoided or must precede fluidization and expansion with water. Use of auxiliary air scour is common in water plants.

- Up flow water wash without auxiliary scour: In the absence of auxiliary scour, washing in an expanded bed occurs as a result of the drag forces on the suspended grains. Grain collisions do not contribute significantly to washing. High rate water wash tends to stratify granular media. In dual and mixed media beds, this action is essential and beneficial, but it is not required for uniformly graded single-medium beds. In rapid sand filters, it results in movement of the fine grains to the top of the bed, which has a negative effect on head loss and run length.
- Up flow water wash with surface wash: Surface wash systems have been widely applied to supplement high rate up flow washing where mud ball formation is likely to be a problem. Either a fixed nozzle or rotary wash system may be used. Fixed systems distribute auxiliary wash water from equally spaced nozzles in pipe grid. Most new plants utilize rotary systems in which pipe arms swivel on central bearings. Nozzles are placed on opposite sides of the pipes on either side of the bearings, and the force of the jets provides rotation.

- Up flow water wash with air scour: Approaches to the use of auxiliary air scour in backwashing filters are numerous. Air scour has been used alone and with low rate water backwash in an unexpanded bed or slightly expanded bed. Each procedure is utilized prior to either low or high rate water wash. Air scour provides very effective cleaning action, especially if used simultaneously with water wash. Cleaning is attributable to high interstitial velocities and abrasion between grains. On the other hand, air wash presents substantial potential for media loss and gravel disruption if not properly controlled.

### 3.3.6 Disinfection

Chlorination became the accepted means of disinfection, and it is the single most important discovery in potable water treatment. Recently, however, the concern over disinfection by-products (DBPs) produced by chlorine has given new impetus to investigating alternative disinfectants. Disinfection of potable water is the specialized treatment for destruction or removal of organisms capable of causing disease; it should not be confused with sterilization, which is the destruction or removal of all life.

Pathogens (disease producing organisms) are present in both groundwater and surface water supplies. These organisms, under certain conditions, are capable of surviving in water supplies for weeks at temperatures near 21° C, and for months at colder temperatures. Destruction or removal of these organisms is essential in providing a safe potable water supply. While the exact effect of disinfection agents on microorganisms is not clearly understood, some factors that affect the efficiency of disinfection are as follows:

- ❖ Type and concentration of microorganisms to be destroyed ;
- ❖ Type and concentration of disinfectant;
- ❖ Contact time provided;
- ❖ Chemical character and
- ❖ Temperature of the water being treated.

**Chlorination:** Chlorine is the chemical predominantly used in the disinfection of potable water supplies. The first application of chlorine in potable water treatment was for taste and odour control in the 1830s. At that time, diseases were thought to be transmitted by odour. This false assumption led to chlorination even before disinfection was understood. Currently, chlorine is used as a primary disinfectant in potable water treatment. Other use include

taste and odor control, algae control, filter-media conditioning, iron and manganese removal, hydrogen sulfide removal, and color removal.

Chlorine is available in a variety of forms, including elemental chlorine (liquid or gas), solid hypo chlorine compounds of calcium or sodium, and gaseous chlorine dioxide. A chlorination system for disinfection of water supply consists of six separate subsystems: (i) chlorine supply; (ii) storage and handling; (iii) safety provisions; (iv) chlorine feed and application; (v) diffusion, mixing and contact; and (vi) the control system. Design considerations for each system are discussed below:

- Chlorine supply: Chlorine is usually supplied as a liquefied compressed gas under pressure. Chlorine can be supplied in containers or in bulk shipment. Selection of the size of chlorine containers or method of bulk shipment mainly depends on (a) the quantity of chlorine used, (b) the technology used in the chlorination system, (c) the space available for storage, (d) transportation and handling costs, and (e) the preference of the plant operator. The cylinders are most likely applied to small water supply systems. The use of 907 kg containers is generally desirable for moderate size users. Bulk shipment may be the cost-effective for large scale water utilities.
- Chlorine storage and handling: The Chlorine storage and handling systems must be designed with full safety consideration; chlorine gas is very poisonous and corrosive. The cylinders and containers storage are usually housed in an enclosure or building. A designer's checklist for ton container storage and handling facilities should include, but not limited to, the following: (a) appropriate auxiliary ton-container valves (captive Yoke type), flexible copper tubing, and a rigid black seamless steel manifold header with valves, fitting, and shut-off valves; (b) container weighing scales or load cells; (c) trunnions for ton containers; (d) ton container lifting bar ; (e) overhead crane or monorail with 3600 kg (4 ton) capacity; (f) chlorine-gas filter; (g) external chlorine pressure reducing valve as necessary; (h) pressure gauges; (i) drip legs ; (i.e, condensate traps) at inlet to chlorinators; (j) continuous chlorine-leak detector with sensors and alarms; and (k) emergency-repair kit for ton-container.
- Safety Considerations: USEPA had set forth the regulations that intended to minimize the risk of injury, death, or damage to the operation personnel and potential off site impact on public and Environmental receptors during an accidental release of chlorine. The 40 CFR Part 68 Accidental Release Prevention Program Rule (ARPPR) applies to many water treatment facilities that have inventories of regulated substances

(i.e, chlorine, ammonia, chlorine dioxide, etc.) in greater quantities than those minimum threshold quantities specified in the regulation. To comply with the requirements in the ARPPR, the Risk Management Program had to be prepared for all regulated facilities by June 21, 1999 and be updated by every five-year anniversary and after any major changes in regulated processes. This shipment, storage, handling, and use of hazardous materials (i.e, Chlorine, Ammonia, etc.) are subject to regulation by DOT, OSHA, and state legislatures.

- Chlorine Feed and Application: The chlorine feed and application system mainly include the following:
  - ❖ Chlorine withdrawal (as gas or liquid chlorine);
  - ❖ Evaporator (necessary for liquid chlorine withdrawal only);
  - ❖ Automatic switchover;
  - ❖ Vacuum regulator;
  - ❖ Chlorinator;
  - ❖ Injector system (with utility water supply);
  - ❖ Diffusion, mixing, and contact;
  - ❖ Control system.

The chlorine feed & application system may also include liquid and gas pressure relief systems, gas pressure reducing valves, gas pressure and vacuum gauges with high pressure & vacuum alarms, gas filters, and several vent line systems.

- Diffusion, Mixing and Contact: Rapid mixing of chlorine solution into water, followed by a contact period, is essential for effective disinfection. The chlorine solution is provided through a diffuser system. It is then mixed rapidly by either (a) mechanical means, (b) a baffle arrangement, (c) a hydraulic jump created downstream of a weir, Venturi flume, or Parshall flume. A diffuser is the device at the end of the solution piping that introduces the chlorine solution into the treated water at the application point.
- Control System: The chlorination system must maintain given chlorine residual at the end of the specified contact time. Chlorine dosage must be adjusted frequently to maintain the required residual chlorine. At small installations, manual control is enough to provide the required chlorine dosage. The operator determines the chlorine residual and then

adjusts the feed rate of chlorine solution. A simple orifice controlled constant head arrangement or low capacity proportioning pumps are used to feed the chlorine solution. Often, constant speed feed pumps are programmed by time clock arrangement to operate the pump at the desired intervals.

At large facilities, complex automatic proportional control systems with recorders are used. Signals from a flow meter transmitter and chlorine residual analyzer are transmitted to the chlorinator to adjust the chlorine feed rate and to maintain a constant chlorine residual that is preset in accordance with the design criteria and standard operating procedures (SOPs). The chlorine analyzers and automatic control loop chlorinator systems are supplied by many manufactures. Several alarms also considered as essential part of the control system. These include high & low pressures in storage vessels, liquid or gas chlorine lines, high & low injector vacuum lines, high & low temperatures for evaporator water bath, high and low chlorine residual and chlorine leaks.

**Ozonation:** Ozone has been used extensively in Europe for disinfection and for taste and odor control in water supplies. Interest in the United States and Canada has increased in recent years because of a growing concern about Trihalomethane (THM) formation during chlorination of drinking water. In addition to its use as a disinfectant, pre ozonation is also used for (a) removal of taste and odor, (b) removal of colour, (c) removal of iron and manganese, (d) enhanced removal of organic matters and (e) oxidation and volatilization of organics.

Ozone is an unstable gas; therefore, it has to be generated on site. In addition, ozone cannot be used as a secondary disinfectant, because an adequate residual in water can be maintained for only a short period of time. Because of its high oxidation potential, ozone requires certain contact time between the dissolved ozone and water. The challenge is to reduce the spreading in contact time (CT: concentration times hydraulic residence time). This spreading is mainly caused by (turbulent) flow and mixing properties. As a micro flocculation aid, ozone is added during or before rapid mix followed by coagulation.

Many studies have shown that pre ozonation enhances coagulation flocculation and improves performance of sedimentation and filtration processes. The advantages and disadvantages of ozonation in water treatment are given in **Table 3.2**

**Table 3.2: Advantages Vs Disadvantages of Ozonation**

<b>S.No.</b>	<b>Advantages</b>	<b>Disadvantages</b>
1.	Complex taste, odor, and color problems are effectively reduced or eliminated	The residual does not last long
2.	Organic impurities are rapidly oxidized	High electric energy input and or eliminated high capital and about 10 to 15 times higher than chlorine is required.
3.	Effective disinfection is achieved over a wide temperature and pH range	High temperature and humidity may complicate ozone generation
4.	Bactericidal and sporicidal action is rapid (300 to 3000 times faster than chlorine); only short contact periods are required	The process is less flexible than those for chlorine in adjusting for flow rate and water quality variations.
5.	Odors are not created or intensified by formation of complexes	Analytic techniques are not sufficiently specific or sensitive for efficient process control
6.	It reduces chlorine demand and in turn lowers Chlorine dosage and so Tri Halo Methane formation potential	Waters of high organic and algae content may require pretreatment reduce to ozone demand
7.	It improves overall treatment efficiency	The overall cost of treatment is high

## **4.0 EFFECTS OF FLUORIDE & ARSENIC AND REMOVAL TECHNIQUES**

### **4.1 Fluoride & its Effects**

Fluoride is essential for human being as it helps in normal mineralization of bones and formation of dental enamel. It adversely affects the health of human being when their concentration exceeds the limit of 1.5 mg/l. About 96% of the fluoride in the body is found in bone and teeth. Fluoride is a double-edged sword. Ingestion of large amount of fluoride is as harmful as ingestion of its inadequate amount.

Inadequate quantities fluoride causes health problems especially in children. In cold countries like USA, UK etc. problems are related to inadequate consumption of fluoride. In these countries, fluoride is added to water to prevent health hazards. There are areas where dental problems have reduced progressively by adding fluoride in water. Due to inadequacy of fluoride, children suffer from:

- Dental caries
- Lack of formation of dental enamel
- Lack of normal mineralization of bones.
- All or a combination of the above

Fluoride poisoning and the biological response leading to ill effects depend on the following factors:

- Excess concentration of fluoride in drinking water.
- Low Calcium and high alkalinity in drinking water.
- Total daily intake of fluoride
- Duration of exposure to fluoride
- Age of the individual
- Expectant mothers and lactating mothers are the most vulnerable groups as, fluoride crosses the placenta because there is no barrier and it also enters maternal milk.

Derangement in hormonal profile either as a result of fluoride poisoning or as a cause, aggravate the disease. Important hormones for healthy bone formation and bone function are calcitonin, parathormone, vitamin - D and cortisone.



Fluorosis, a disease caused by excess intake of fluoride, is a slow progressive, crippling malady. The tissues affected by fluoride are;

- Dental
- Skeletal
- Non Skeletal

Different fluoride doses (long term ingestion through water) and their effects on human body are given below:

<b>Fluoride (mg/l)</b>	<b>Effects on human body</b>
Below 0.5	Dental caries
0.5 to 1.0	Protection against dental caries. Takes care of bone and teeth
1.5 to 3.0	Dental fluorosis
3 to 10	Skeletal fluorosis (adverse changes in bone structure)
10 or more	Crippling skeletal fluorosis and severe osteoclerosis

## **4.2 De- fluorination**

Several methods have been suggested for removing excessive fluorides in drinking water. These may be broadly divided into two types.

- 1) Those based upon exchange process or adsorption
  - 2) Those based upon addition of chemicals during treatment.
- ❖ The material used in contact beds includes processed bone, natural or synthetic tri calcium phosphate, hydroxy apatite magnesia, activated alumina, activated carbon and ion exchanger.
  - ❖ Chemical treatment methods include the use of lime either alone or with magnesium and aluminium salts again either alone or in combination with coagulant aid. Other methods include addition to fluoride water of material like Magnesia, calcium phosphate, bentonite and fuller's earth, mixing and their separation from water by settling and filtration.

### **4.2.1 Nalgonda Technique**

The Nalgonda Technique involves the addition of two simple readily available chemicals Lime and Alum, followed by flocculation, sedimentation & filtration in sequence. These operations are simple and familiar to the engineers.

### **A. Fill and draw Type for small community**

This is a batch method for communities upto 200 population. The plant comprises a hoper bottom cylindrical tank with a depth of 2 meters, equipped with a hand operated or power driven agitator paddles. Raw water is pumped or poured into the tank and the required amount of bleaching powder, lime or sodium carbonates are added prior to stirring and alum is added during stirring. The contents are stirred slowly for 10 minutes and are allowed to settle for 2 hours. The defluoridated supernatant water is withdrawn for supply through stand posts and the settled sludge is discarded.

### **B. Fill and draw type for rural water supply in batches**

This system is basically similar except that two large sized units are used for treating water. Two units in parallel are installed each comprising of cylindrical tank of 10 m<sup>3</sup> capacity with dished bottom inlet outlet and sludge drain system. Each tank is fitted with an agitation assembly consisting of a (a) 5 HP motor 3 phase 50 Hz 1440 rpm with 415 ± 6% voltage fluctuation. (b) Gear box for 1440 RPM input speed with reduction ratio 60:1 to attain a speed of 24 rpm, complete with downward shaft to hold agitator paddles. The agitator is fixed to the bottom of the vessel by sturdy suitable stainless steel bushings.

### **Merits of Nalgonda Techniques over other methods:**

- No regeneration media.
- No handling of acids and alkali
- Readily available chemicals used in conventional municipal water treatment are only required
- Adoptable to domestic use
- Flexible up to several thousand m<sup>3</sup> / day
- Applicable in batch as well as in continuous operation.
- Simplicity of design, construction, operation and maintenance
- Local skills could be readily employed
- Highly efficient to remove fluorides from 2 to 20 mg / l at desirable level
  
- Simultaneous removal of colour, odour, turbidity, bacteria and organic contaminants.
- Normally, associated alkalinity ensures fluoride removal.
- Little wastage of water.
- Needs minimum mechanical and electrical equipment.
- No energy except muscle power is needed for domestic treatment.

- Cost efficient annual cost of defluoridation of water at 40 lpcd works out to be Rs.15/ for domestic treatment & Rs.30/- for community treatment based on 5000 population for water with 5 mg / l F and 400 mg / l alkalinity which requires 600 mg / l of alum.

### **Demerits of Nalgonda Technique**

- Contrary to the claims made by NEERI, in some case, in domestic defluoridation, the flocs do not settle completely after 1 hr. In Fill & Draw type defluoridation plants, flocs do not settle completely in 2 hrs. At times it may take 4 hrs.
- Due to organoleptic reasons, villagers complain about palatability.
- Villagers do not want to pay attentions for 2 hrs. for such type of treatment process. They want some ready made treatment.
- Alum dose correspondingly increases sulphate concentration, by 35%. Therefore, in many cases the treated water contains sulphate concentration, more than 400 mg / l thereby causing the water un-potable.
- In addition to above, more sulphate ion concentration gives pitting effect on RCC.
- In case of improper treatment, it is very likely that aluminium ion concentration will be more than 0.2 mg/l in the treated water. This may give rise to a disease called dementia.
- In Fill & Draw type plants, gear fitted with stirrer, often requires maintenance.
- Frequent power cuts are common in rural areas. In case of sudden power cut, reaction is incomplete and it is quite possible that alum mixed water is supplied to the public.

#### **4.2.2 Activated Alumina**

The capacity of the medium is approx. 1400 mg F per litre of alumina. The bed is regenerated with 1 % NaOH, followed by neutralization of excess alkali. The most important single factor affecting fluoride exchange capacity is alkalinity.

#### **4.2.3 De- fluorination (Hand Pump) based on Activated alumina**

To install a defluoridation plant, the sprout level of hand pump is raised by 1.5 m from the normal level by adding additional pedestals. A bypass arrangement is provided to draw water directly from the hand pump for non drinking purposes. When treated water fluoride concentration is more then 1.5 mg / l, the regeneration of activated alumina is carried out in-situ manually. Regenerates used are 1% NaOH and 0.4 NH<sub>2</sub>SO<sub>4</sub>. De-fluorination (Hand

Pump) based on activated alumina is much better than De-fluorination (Hand Pump) based on Nalgonda Technique.

#### **4.2.4 Artificial Recharge Techniques**

When the existing source of drinking water is high-fluoride-groundwater, various artificial recharge techniques can be applied depending upon the hydro geo environment condition and availability of good quality water to improve the quality of existing ground water by dilutions.

#### **4.2.5 Aquifer Storage Recovery**

The aquifer storage recovery being followed in many parts of the world is technology for storing water underground through wells during times when it is available and recovering this water from the same wells when needed to meet peak, long term and emergency water needs. This technique is being applied throughout the United States, and also in Canada, England, Australia, Israel and other countries. This technique has proved to be a viable, cost effective option for storing large volumes of fresh water not only in fresh, but also in brackish and other non-potable aquifers at depths up to 900 m. Most of this sites store drinking water in confined aquifers containing water quality that is brackish or contains constituents such as nitrates, fluorides, iron, and manganese, all unsuitable for drinking purposes except following treatment. Mixing between the drinking water and the native water in the aquifer can be controlled in most situations by the proper design and operation of aquifer storage recovery wells, so that recovered water quality is acceptable. Operation includes development of a buffer zone surrounding the aquifer storage recovery wells to contain the stored water, and development of a target storage volume for each well so that recovered water will meet flow, volume and water quality criteria with acceptable reliability. This technique, however, still remains to be tried in India. Looking at the success achieved through aquifer storage recovery wells in many countries; this technology may be explored at suitable location (s) in the country.

#### **4.2.6 Ion Exchange method**

A simple version of this method, using aluminium oxide as ion exchanger, is marketed in India under the name "Prasanthi technique". The raw water is poured over an aluminium oxide filter and the de-fluoridated water is then stored in a storage tank. Aluminium oxide is amphoteric with its iso-electric point at approximately pH 9.5. In most natural waters, it removes anions below this pH and cations above. There are models available both for domestic and community use. The manufacturer describes the procedure to be followed while using these plants in five steps; acidification, loading, backwashing, rinsing and regeneration. The frequency for backwashing and rinsing is not included in the

information from the manufacturer. Regeneration has to be done once in a year for the domestic plants and once a month for the community plants.

### 4.3 Arsenic & Its Effects

Arsenic adversely affects the health of human being when their concentration exceeds the limit of 0.05 mg/l. High concentrations of Arsenic are found mostly in ground water from natural deposit in the earth or from Industrial and agricultural pollution. Arsenic is a natural element of the earth's crust. It is used in industry and agriculture, and for other purposes. It is also a by-product of copper smelting, mining and coal burning.

In the State of West Bengal, source of arsenic is geogenic and associated with iron pyrites in arsenic rich layers occurring in the alluvium alongside the river Ganga. The availability of arsenic is possibly due to excessive use of ground water irrigation (e.g. upto 80% of the annual replenishable recharge in North 24 - pargans) for multiple cropping which causes dropping of water levels resulting exposure of the arsenic rich beds to air (oxidation of the pyrite and solubilization of arsenic).

According to study carried out by the National Academy of Sciences during 1999 reveals that arsenic in drinking water causes bladder, lung & skin cancer, and may cause kidney & liver cancer. The study also found that arsenic harms the central and peripheral nervous systems, as well as heart & blood vessels, and causes serious skin problems. It also may cause birth defects and reproductive problems. The table below shows the lifetime risks of dying of cancer from arsenic in tap water (for different concentration and assuming 2 liters consumed per day) based on the National Academy of Sciences' 1999 risk estimates:

#### **Arsenic Concentration in Tap Water Vs Cancer Risk**

<b>Arsenic Level</b>	<b>Approximate Total Cancer Risk</b>
0.5 ppb	1 in 10,000
1 ppb	1 in 5,000
3 ppb	1 in 1,667
4 ppb	1 in 1,250
5 ppb	1 in 1,000
10 ppb	1 in 500
20 ppb	1 in 250
25 ppb	1 in 200
50 ppb	1 in 100

#### 4.4 Arsenic removal Plants

Arsenic Removal Plants have been designed by various organizations using different technologies and some of these are installed in the Arsenic affected areas in the State of West Bengal. The salient features of these plants are discussed in the following sections.

##### 4.4.1 Plants developed by Department of Public Health Engineering, Bangladesh

Two bucket arsenic mitigation method developed by the Department of Public Health Engineering (DPHE), Bangladesh and Danida is based on the oxidation of all aqueous arsenic to As (V), arsenate, and subsequent co-precipitation with aluminum sulfate (alum).

The materials required are:

- 2 numbers of 20 liter plastic buckets (one red and one green)
- 2 plastic taps
- 1 plastic funnel with nipple and below
- 10 “length of 1/2 “ PVC pipe
- 5 kg coarse sand
- Flat metallic cover for lower bucket
- stirring rod
- measuring scoop
- chemical powder (4 g alum and 0.03 g potassium permanganate per 20 litre)

**Method:** The buckets are colored in analogy to the nationwide practice of painting arsenic affected tube wells red and safe ones green. The red bucket is placed on top of the green one, and they are connected via a plastic tap about 10cm from the bottom of the top bucket, which empties into plastic tubing that channels the water into a filtering device inside the bottom bucket. The filter is a ten-inch length of PVC pipe filled with sand. The water enters the pipe at the top, passed through ten inches of sand and exists through a screen at the bottom. Water is drawn from the bottom (green) bucket via another plastic tap about two centimeters from the bottom of the bucket.

Untreated tube well water is poured into the top bucket, the alum and potash powder is added and the solution is stirred vigorously for 10-15 seconds. After roughly an hour of coagulation, flocculation, and sedimentation, the tap can be opened for the water to flow into the green bucket. The sand filter provides additional protection to keep the flocculate out of the drinking water, which is drawn directly from the green bucket. Weekly cleaning of the sludge from the top bucket seems to be sufficient.

One, problem with the production of the chemical power is that it must be very fine in order to dissolve in an acceptable amount of time and two, works with adequate efficiency. However, the production of such fine power is not impossible.

#### **4.4.2 Plants developed by B.E. College, Howrah**

This system was developed using activated alumina which can adsorb As (+5) significantly and also As (+3) to some extent. Use of activated alumina brought down iron content along with arsenic. Once its capacity is exhausted, activated alumina can be regenerated. The unit packed with 95 kg. Alumina can treat about 10 lakh litre of arsenic laden water. This unit fitted with tube well, which contains arsenic of about 0.14 mg / l, after treating, the level of arsenic in drinking water is reduced to 0.006 mg/l.

#### **4.4.3 Plants developed by the All India Institute of Hygiene and Public Health, Kolkata**

This system based on coagulation-flocculation-sedimentation-filtration method. Water is treated using bleaching powder at the rate 2 mg/l and alum at the rate of 40 mg/l. Bleaching powder is added for oxidation of As (+3) to As(+5). The system comprises circular tanks with a capacity of 1000 litre. Finally, the water passes through a tank (sand media) containing gravels of 5 mm thick to remove suspended particles. The volume of water treated is 10,000 -12,000 litre in 12 hours. The dosing of bleaching and alum solution is continuous. Dosing of chemicals is continuous but intake of water is not continuous and therefore, there may be chances of over dosing resulting enhancement of chlorine. As claimed by institute, this will not happen due to 1000 litre of capacity of tank which would minimize accumulation of excess chlorine. In any case, there is no chance of leaving the tube well unused for more than one hour even during 1 PM to 4 PM. Some technical and operational problems may be expected due to continuous addition of chemicals to water in absence of operator all the time. The operation cost of this unit is Rs. 1.10 per litre.

#### **4.4.4 Plants developed by M/s. Pal Trockner Pvt. Ltd.**

M/s. Pal Trockner Pvt. Ltd. has installed unit at Barasat, 24 Parganas. This system developed by M/s. Harbauer, GmbH, Germany' is called Absorp AS. It is a granular activated ferric hydroxide with a specific surface of 250-300 m<sup>2</sup> /g and a porosity of 75-80%. Drinking water containing Arsenite and Arsenate while passes through adsorbent (Adsorp As) bind on the surface of ferric hydroxide, building inner spherical complexes. This bonding is irreversible under normal environmental condition. This granular activated ferric hydroxide reactor is fixed bed absorbers operating like conventional filtration process with a down water flow. This unit consists of a gravel filter followed by an adsorption

tower filled with adsorber. This granulated ferrous hydroxide is produced by the reaction of iron tri chloride with caustic soda and subsequently submitted to a comprehensive refining process. This system functions efficiently if the pH of the water is between 5.5 and 9.0. The capacity of the 'Adsorp As' is between 15 and 30 gm arsenic removed per kg "Adsorp As" depending on the quality of raw water. As reported, the spent 'Adsorp As' is a solid, non-toxic waste and not a slushy sludge. This does not require regeneration. As a result it does not produce toxic and hazardous waste. Therefore, disposal is less problematic. It has been reported that under normal environmental conditions, no leaching of arsenic took place from the spent 'Adsorp As'. This spent 'Adsorp As' can be advantageously used as a useful coloring element for manufacturing bricks.

#### **4.4.5 Plants developed by the P.H.E. D., Govt. of West Bengal**

The Arsenic removal plant designed by P.H.E.D. and installed at Sujapur (Malda) involves: Chemical oxidation using chlorine, Coagulation by rapid mixing using ferric chloride, Sedimentation and Filtration. In this process, As(+3) present in water is oxidized to As(+5) and then Arsenic in both forms are removed from aqueous solution by coagulation, sedimentation & filtration process. The removal efficiency was found in the order of 90-93%. According to PHED report, the leachability of arsenic from the sludge at different pH is insignificant. To minimize the leaching of Arsenic, sludge should be kept by making blocks with cement and coarse aggregates. With variation of water quality with respect to iron and arsenic, performance of plant was observed to be consistently good.

Another pilot plant coupled with a small bored tube well and lift pumps was installed at Jhaudia in Murshidabad district in August 1999. The water treated by this plant is used by 50 families. The treatment process for removal of Arsenic from aqueous solutions involves: Oxidation through dry filter, Co-precipitation of arsenic with iron and Up-flow filtration through coarse media.

Tertiary treatment by adsorption is required if Arsenic content is more than 0.05 mg / l at the end of preceding treatment. There are four chambers to accomplish treatment in stages. Red hematite, quartz, sand materials and activated alumina are used in the pilot plant. Input rate of tube well should be 15 to 18 litre per minute. The removal of arsenic was reported from 206 mg / l to below permissible limit. Arsenic sludge is to be disposed by absorption through common aquatic plant. PHED in collaboration with DELOC laboratory also developed water filter to remove Arsenic from ground water on a continuous basis. This system employs adsorption mechanism of sorption of arsenic in ground water. The adsorbent is mainly activated alumina along with some ferruginous materials. This filter is of plastic body with two annular cylinders (one for containing the media and other is hollow for collection of water).



#### **4.4.6 Plants developed by M/s. Adhiacon Pvt. Ltd., Kolkata**

The plant has been developed by M/s. Adhiacon Pvt. Ltd. based on catalytic precipitation method. It is working at Baruipur since July, 1999. The principle of this system is to commence filtration with oxidation of arsenite to arsenate by the energy generated from the water with the help of media (potential difference). The system triggers off a series of catalytic reactions by which many soluble metal ions i.e. chromium, lead, copper, iron etc. are precipitated as their insoluble hydroxide. This reaction is having a cascading effect in which arsenate ions reaction with ferric hydroxide form insoluble form of arsenate. The system comprises three cylinders. The first cylinder is packed with media (the composition of media is not disclosed) and second cylinder with media and granulated activated carbon separately. The hydroxides coated over granules through reaction are removed through back flushing to third cylinder for storing. Requirement of flushing depends on the concentration of metals in raw water. The flow rate is 1000 litre /hour.

#### **4.4.7 Plants developed by School Of Environmental Studies(SOES), Jadavpur University, Kolkata and CSIR, New Delhi**

School Of Environmental Studies (SOES), Jadavpur University, Kolkata in collaboration with CSIR has developed table and filter candle. The main ingredient of the candle is fly ash. Use of fly ash makes the filter candle hard. Investigations were carried to study the impact of the candle on water. The filter in combination with a chemical tablet can remove almost 100 percent both AS (+3) and As(+5) from ground water. The system is cost effective, durable and meant for daily use. The complete system consists of mud jars, filter candle and tablet. This can be used for one year at the cost of Rs. 200/- (Two hundred) only. The system was tried in affected districts for studying its efficiency. The details about composition of the tablet could not be obtained as it has been filed for patent jointly by SOES, J.U. and CSIR, New Delhi. According to the report, arsenic compound accumulated on the filter candle is washed and washing of the filter along with some cow dung would not contaminate the soil since microorganisms present in the cow dung would convert the inorganic arsenic to methylated form which would be released in to the air.

#### **4.4.8 Developed by M/s RPM Marketing Pvt. Limited**

The system is based on adsorption method using Activated Enhanced Hybrid Alumina (AEHA). The system has two chambers. The first chamber packed with gravel followed by a chamber of 50 liters capacity containing activated enhanced hybrid alumina. The installed capacity of this unit is 1,50,000 liters. The flow rate is about 15 liters / min.

#### **4.4.9 Developed by M/s Anir Engineers Inc**

The system is based on the adsorption technique using Fixed Bed Granular Ferric Hydroxide (GFH). GFH is prepared from ferric chloride solution by neutralization and precipitation with sodium hydroxide. The grain sizes vary from 0.2 to 2.0 mm, as the grains with water resulting high density of available adsorption sites. This in turn, enhances the adsorption capacity. It is operated with down stream water and operated in the pH range between 5 to 10. The typical residual mass is in the range 5 - 25 gm / m<sup>3</sup> treated water.

## **5.0 OPERATION & MAINTENANCE OF WATER TREATMENT PLANTS**

### **5.1 Operation Problems**

In most of the cases, although Water Treatment Plants are designed and got constructed by State Public Health Engineering Departments or concerned Water Supply and Sewerage Boards, their operation and maintenance is carried out by local Municipal Corporations. There is an emerging new trend to engage a private organization on contract for operation & maintenance of water treatment plants. In certain cases, it is carried out by Water Supply and Sewerage Boards or PHEDs. It is clear that no set pattern is followed in this regard.

Desirable operation and maintenance practices for important units are discussed below:

### **5.2 Rapid Mix and Flocculation Facilities**

#### **Operational Problems**

Operational problems associated with coagulation and flocculation processes typically relate to either equipment failure or process inefficiencies. Problems associated with equipment operations are specific to the installed equipment and are not discussed here. Problems associated with the coagulation process are typically indicated by high turbidity water in the sedimentation basin effluent and / or the filtered water. Some of the common causes for poor performance of coagulation and flocculation facilities are as follows:

- High effluent turbidity, with no floc carryover, can be the result of too little coagulant or of incomplete dispersion of the coagulant. Jar tests with varying coagulant dilutions and rapid-mix intensities should be performed and dose to be adjusted accordingly.
- Unsatisfactory effluent turbidity can also result from raw water that has low initial turbidity. An insufficient number of particle collisions during flocculation will inhibit floc growth. Increase flocculation intensity, recycling of sludge, or addition of bentonite provide a nucleus for floc formation.

- High effluent turbidity with floc carryover is an indication of a poor settling of floc. High flocculation intensity will often shear floc and result in poor settling. Lowering the flocculation intensity, or add a coagulant aid will toughen the floc and make it more readily settleable.
- Too much coagulant will often result in restabilization of the colloids. If unsatisfactory performance is obtained, a series of jar tests with various coagulant dosages will help in determining appropriate dosage requirement. The feed rates should be adjusted accordingly.
- Calcium carbonate precipitate will often accumulate on lime feed pipes. Lime pipes should be flushed with an acid solution periodically, to dissolve the scale.
- Improper feed rate of coagulant through positive displacement metering pumps can be the result of siphoning through the pump. Pumps may be located in such a way that a positive head is present at all times on the pump discharge. An alternative correction method is to install a back-pressure valve on the pump discharge.

### **Preventive Maintenances**

The following preventive maintenance procedures are necessary for the satisfactory operation of rapid mix and flocculation facilities.

- Performing jar tests on raw water samples daily when significant raw water quality changes are experienced. The coagulant dosages and mixer speeds should be adjusted accordingly.
- Cleaning of accumulated precipitate and sludge from rapid mix and flocculation basins.
- Every month calibration of chemical feeders.
- Checking the chemical analysis of each delivery of coagulant. Adjusting feed rates as indicated by the analysis and jar tests.
- Lubricating the flocculator and mixer gear boxes and bearings as specified by the manufacturer.
- Inspect rapid mix impellers and flocculator paddles annually. Removal of any accumulations of floc or calcium carbonate scale. More frequent inspections are required if build up is severe.

## 5.3 Sedimentation Facilities

### Operational Problems

Operational problems associated with sedimentation basins typically relate to ineffective sludge removal or short circuiting. Ineffective sludge removal commonly is associated with equipment problems or inadequate sludge removal practices. Short circuiting is typically the result of improper inlet or outlet design; it can also be the result of wave action, density currents or temperature currents. Common operational and maintenance problems and troubleshooting guides are as follows:

- Operational problems with sludge collection equipment may include the shear pins or motor overloads or both, generally due to improper sludge removal. Rapid checks include removal of sludge, ensuring proper shear pin installation, motor overload setting and also to remove debris in the basin.
- Sludge withdrawal with low solids concentrations may result from an excessively rapid removal rate or improperly operated sludge collection mechanism. Checks include decreasing the removal rate and to ensure proper operation of sludge collection equipment.
- Clogged sludge withdrawal piping can be the result of insufficient sludge withdrawal, therefore, increases the removal rate.
- High effluent turbidity or floc carryover may result from an improper coagulation process. High turbidity or floc carryover may also result from short circuiting in the sedimentation basin. Possible corrective measures include inlet and outlet baffles. Tracer studies help in identifying short circuits.
- Algae build up on basin walls or weirs may create taste and odor problems. Regular cleaning of basin walls, maintaining a residual disinfectant in the basin, restricting algae growth is required.
- Sludge with a high organic content may impart taste and odor problems to the finished water, therefore sludge removal rate may be increased.

### **Preventive Maintenances**

The following preventive maintenance procedures are necessary for satisfactory operation of the sedimentation facility:

- Cleaning of basins annually to remove any accumulated sludge and algal growth
- Lubrication of the sludge collection equipment as recommended by the manufacturer
- Testing the sludge collection overload devices annually.
- Testing the solids content in the sludge withdrawal line daily.
- Turbidity of effluent may be checked on a regular basis and whenever the water quality or flow rate changes.

## **5.4 Filtration Systems**

### **Operational Problems**

- Improper operation of filtration units can result in poor quality of finished water and damage to the filter bed. In order to ensure proper operation, operators must continually monitor the operation of the filter units. The filtered water turbidity and the head loss through each filter unit are of particular interest.
- The filters must be backwashed as soon as either the filtered water turbidity or the head loss through a filter unit reaches a preset maximum value. Also, if a filter unit has been idle for a period of time; it should be thoroughly backwashed prior to its being put back into service.
- Improper filter backwashing may cause inadequate filter cleaning and possible damage to the unit. If the back wash water is introduced too rapidly, the filter bed can be disturbed, or, in extreme cases, the filter bottom can be damaged. In order to reduce the chances of damage to the filter beds from improper backwashing techniques, most filter systems utilize automatic backwash controls.

- The two most common problems encountered in filter operation are mud ball formation and air binding. Mud ball formation is usually the effect of improper backwashing techniques, but improper media selection can also be the cause. Single medium filters historically show a greater tendency to form mud balls than do properly designed dual media and mixed media filters. Surface wash, sub-surface washing, or air scouring of filters before and during backwash also reduces the tendency to form mud balls in the filter bed.
- Once mud balls have formed in a filter bed, the most effective means of removing them is to remove the filter media and either replace it or thoroughly clean the media before placing them back into the bed. Once mud ball have begun to form in a filter bed, they will usually grow larger.
- Air binding of filter beds is usually caused by improper hydraulic design of the filter system. Possible solutions to air binding are (i) replacing the filter media with one with a different gradation, (ii) reducing the maximum flow rate through the filter and (iii) Inducing additional hydraulic head in the filter effluent, to raise the hydraulic gradient in the filter bed

### **Brief trouble shooting guide**

#### **Condition 1: High head loss through a filter unit or filter run**

Possible cases are:

- ✓ Filter bed in need of backwashing
- ✓ Air binding
- ✓ Mud balls in the filter bed
- ✓ Improper rate of flow controller operation
- ✓ Clogged under drains
- ✓ Improper media design: too small (or) too deep
- ✓ Floc strength too strong – will not Penetrate media

#### **Condition 2: High effluent turbidity**

Possible cases are:

- ✓ Filter bed in need of backwashing
- ✓ Rate of flow too high
- ✓ Improper rate of flow controller operation
- ✓ Disturbed filter bed
- ✓ Mud balls in the filter bed

- ✓ Air binding
- ✓ Inappropriate media size or depth
- ✓ Low media depth (caused by loss during back wash)
- ✓ Floc too small or too weak caused by improper chemical pretreatment.

## **5.5 Disinfection Facility**

Routine maintenance should be scheduled to assure that problems are corrected before unnecessary damage occurs to the equipment. In this way, unplanned chemical and labour costs can be reduced, treatment efficiency maintained and many safety hazards prevented.

Routine operation and maintenance of the chlorine feed systems includes the following.

- Inspection of the chlorinators, evaporators, and storage tanks each day to ensure proper operation. Low gas pressure or no feed may indicate flow restrictions, empty vessels, clogged injectors, or damaged equipment.
- Inspection of the diffusers. Diffusers may become plugged.
- Monitoring of the combined and total chlorine residual daily. Excess variations may indicate equipment malfunction.
- Monitoring of the treated water quality daily. Perform a periodic review of treated water quality. This should include analysis of daily reports.
- Draining of the contact chambers annually and repair of structures and equipment as needed.
- Testing of leak detectors and emergency equipment every six months and verifying of operator training in emergency procedures.

## **5.6 Management Information System and Indicators**

The efficient and effective performance of an agency depends on a clear relationship between management activities such as planning, organization, selection and training of staff, coordination, direction and control of the functions of the agency. The interaction between the individuals at different management levels, together with use of information in the decision making process, is important to the agency's performance. Each of the management levels has different centres of decision and each of these is supported by an information system.



Management Information System is defined as a formal system of making available to the management accurate, timely, sufficient, and relevant information to facilitate the decision making process to enable the organization to carry out the specific functions effectively and efficiently in tune with organization's objectives. Organizations have many information systems serving at different levels and functions within the organizations. The data fed into the management information system initially is internal data and later data from other institutions such as from community and others can also be fed. Each agency has to decide as to which information is relevant and then evolve its own procedures for accurate collection, measurement, recording, storage and retrieval of data. The management information system can be developed either by manual data collection or by use of software.

The result of actions by managers at the strategic, tactical and operational level is measured by Management / Performance Indicators. These Indicators represent a situation, an event or a change brought about by an action aimed at achieving a target set by an agency. These indicators allows the management to set targets, monitor the O&M, evaluate the performance of the agency and take necessary decisions and corrective actions.

## 5.7 Organizational Structure

In order to achieve the objectives of the operational system, efficient administration of the processes is necessary. Management uses the productive capacity of the agency's staff to achieve the objectives.

Managers are responsible for influencing how the agency is organized to attain its objectives. The organizational structure should be such that it allows coordination between all units of O & M. Human, financial and material resources should be constantly available for carrying out the O & M activities. Management activities and centres of decision are organized according to the authority and coordination.

**Management Levels:** The levels of management and assignment of functions will vary from agency depending on the situation and the staff. Normally there are three levels viz. senior, middle and operational management. These levels and their functions are as follows:

- ❖ **Senior management** responsibilities include: decisions which will have long term effect and setting objectives for quantity and quality of water, setting priorities for expansion of coverage and setting targets to be achieved, administration of personnel matters and efficient use of funds,

conversation of water (prevention of wastage of water), arranging for a situation analysis and taking up long term planning and forecast of the agency's ability of provide coverage at lowest cost, raising productivity levels, ensuring that best safety procedures are followed etc.

- ❖ **Middle management** is concerned with how efficiently and effectively resources are utilized and how well operational units are performing , prepare medium term plans including procurement and distribution of resources, expanding coverage of services, reducing water losses, reducing costs and increasing productivity, monitoring water quality etc.
- ❖ **Operational management** is to ensure that operational units work efficiently and last as long as possible, work for reducing and controlling leaks, undertake measurement of flows and pressures and monitoring the performance of water supply system, ensure quality control of water in production and distribution, implement preventive maintenance programs, improve efficiency, increase productivity and reduce costs and establish lines of communication with community and foster good public relations.

**Size of Organization and Scale of Operations:** The agency has to adapt to the environment in which it operates and hence will have organizational units to suit its size and complexity. In an agency that serves only one local area, all managerial functions can be carried out at the local level. Metropolitan and regional agencies will need to regroup senior and middle management centrally and delegate operational management to local or area levels depending on the number of localities for water supply, the agency may set up intermediate (circles), regional (divisions) or sub regional (sub divisions) for operational management of O & M with a concentration of technical resources such as equipment, qualified staff, workshops, transport etc to supervise and support operations at local level.

Normally an agency has decision centres at three levels, strategic at senior level, tactical at Middle level and operational. Strategic decisions are those with long term influence. Tactical decisions are effective in the medium term and operational decisions apply to short term.

## 6.0 WATER QUALITY CONTROL AND ASSESSMENT

### 6.1 Water Quality Monitoring

Water quality control and assessment should always be seen in the wider context of the management of water resources and treatment, encompassing both the quality and quantity aspects. The usefulness of the information obtained from monitoring is severely limited unless an administrative and legal framework (together with an institutional and financial commitment to appropriate follow up action) exists at local regional and national level.

There are four main reasons for obtaining inadequate information from assessment programme have been defined and are applicable for ground and surface waters:

- The objectives of the assessment were not properly defined.
- The monitoring system is installed with insufficient knowledge of the water resources and treatment.
- There is inadequate planning of sample collection, handling, storage, and analysis.
- The data are poorly and improperly interpreted, reported, documented, and stored.

To ensure that these mistakes are avoided, following ten basic rules for a successful water quality monitoring and assessment programme are proposed:

- ✓ The objectives must be defined first and the programme adopted to meet the objective and not vice versa. Adequate financial support for the purpose must be arranged.
- ✓ The type and nature of the water body must be fully understood, most frequently through preliminary surveys, particularly the spatial and temporal variability within the whole water body.
- ✓ The appropriate media (water, particulate matter, and biota) must be chosen.
- ✓ The variables, type of samples, sampling frequency and station location must be chosen carefully with respect to the objectives.

- ✓ The field, analytical equipment, and laboratory facilities must be selected in relation to the objectives and not vice versa.
- ✓ A complete and operational data treatment scheme must be established.
- ✓ The monitoring of the quality of the aquatic environment must be coupled with the appropriate hydrological monitoring.
- ✓ The analytical quality of the data must be regularly checked through internal and external control.
- ✓ The data should be given to decision makers, not merely as a list of variables and their concentrations, but interpreted and assessed by experts with relevant recommendations for management action.
- ✓ The programme must be evaluated periodically, especially if the general situation or any particular influence on the environment is changed, either naturally or by measures taken in the catchments area.

## 6.2 Environmental Observation

General definitions for various types of environmental observation have been listed as follows, which may be interpreted for the water resources and the treatment of water:

**Monitoring:** Long term, standardized measurement, observation, evaluation and reporting of the aquatic environment and treatment of water in order to define status and trends.

**Survey:** A finite duration, intensive programme to measure, evaluates and reports the quality of water sources and treatment for a specific purpose.

**Surveillance:** Continuous, specific measurement, observation, and reporting for the purpose of water quality management and operational activities.

Monitoring, survey and surveillance are all based on data collection, evaluation and reporting.

### 6.3 Minimum sampling requirements

In countries where there are no legal requirements for sampling, the following regime would provide an adequate minimum level of monitoring, linked with the priorities suggested.

Simple chemical tests should be carried out daily on the raw water and also treated water leaving the water treatment works. Samples should also be taken at least weekly at consumers' taps. The tests should be for more easily measurable but important parameters such as colour, taste, odour, turbidity, pH, conductivity, and chlorine residual in case of treated waters. Other parameters might be included in respect of a particular source of situation. Among these might be chlorides to test for salt water intrusion or sewage pollution, nitrate and ammonia to indicate pollution, iron, lead, and arsenic in special cases and residual coagulant and hardness for checking treatment performance.

Full chemical analysis should be carried out, including test for toxic substances, on any raw water source to be used for new supplies, whenever treatment processes are being altered and when new sources of pollution are suspected. Routine samples for full chemical analysis of water in distribution system should be taken quarterly, half yearly or yearly, depending on the size of the population catered. Checking for the presence of substances of health significance, for example tri halo methane, pesticides, PAH and the heavy metal may need to be more frequent, if they are a cause for concern.

The availability of well equipped laboratories and resources for water quality testing are very limited for many water undertakings. The level of testing under such circumstances must concentrate on the most essential parameters. These parameters have been adequately elaborated in various standard specifications for water quality and treatment available in the country.

Sample checks at water treatment works are:

- Twice daily checks should be carried out on chlorine dosage rate and the residual chlorine content of water entering into the distribution system.
- Daily measurement on samples of raw water and treated water should be carried out for turbidity, colour, odour, conductivity and pH value.

- Where coagulation, clarification and filtration are applied, daily checks should also be carried out on dosages of coagulants, and the pH, and turbidity of the water ex clarifiers and ex filters.
- Where possible, analysis for total and faecal coliforms should be carried out at least weekly on the sample of the treated water leaving the water treatment plant.

#### **6.4 Monitoring for Contaminants**

Monitoring of contaminant parameters and their frequency for public water supply Systems as suggested by EPA is given here, with the intention that it may be taken into account while deciding on contaminants and their frequency of monitoring for our country.

Public water systems are classified into two major categories. Those serving permanent populations like cities and towns and are called “Community Systems”. Those serving facilities like hotels, restaurants, youth campus, highway rest-stops, and travel- trailer campgrounds are called “noncommunity systems”. These non-community systems are further divided into those serving a transient population, such as restaurant and campgrounds and those serving non transient population such as hotels and schools.

Transient community systems are required only to monitor and treat for nitrate, nitrites and fecal coliform. Both community systems and non transient non-community systems must monitor and treat water to standards set by the federal government and enforced by the states. Communities less than 15 connections or 25 people are not considered to be “Public water systems” and are therefore not regulated. Frequency of monitoring for contaminants in drinking water is given in **Table 6.1**.

**Table 6.1: Frequency of Monitoring for contaminants in Drinking Water**

<b>S.No.</b>	<b>Contaminant</b>	<b>Minimum Monitoring Frequency</b>	<b>Applicable system</b>
1.	Bacteria	Monthly or quarterly, depending on system size and type	C.N.T
2	Protozoa and Viruses	Continuous monitoring for turbidity, monthly for total Coli forms as indicators	C.N.T
3	Volatile Organics (eg : benzene)	Ground water systems - annually, for two consecutive year; Surface water systems - annually	C.N.
4.	Synthetic Organics	Larger systems - twice in three Years; smaller systems - once in Three years	C.N.
5.	Inorganic / metals and Nitrites	Ground water systems - once in every three years; Surface Water Systems - annually	CN for most, and CNT for Nitrates
6.	Lead and Copper	Annually	C.N.
7.	Radi -nuclides	Once every four years	C

**Note:** C – Community; N – Non-Transient, Non-Community, T – Transient, Non-Community

## 7.0 RESULTS AND DISCUSSION

### 7.1 Raw Water Quality

Characteristics of raw water were obtained from few water treatment plants during the visits. The processed information is summarized in **Table 7.1**. Raw water quality of water treatment plant at Agra, being significantly affected by organic pollution, is specifically given in **Table 7.2**. It can be seen from these tables that primary parameters of concern is turbidity. However, in case of Agra, raw water source is Yamuna River, which is polluted. The level of pollution is so high that its use as raw water source becomes a major issue of concern. The raw water quality at other locations may be considered suitable in respect of ability of treatment plants to produce good quality treated water.

### 7.2 Coagulation and Flocculation

Alum is being added as coagulant in almost all the water treatment plants. However, recently some water treatment plants at Nashik and Pune have started using Poly Aluminium Chloride (PAC) instead of Alum, which is in liquid form. Water treatment plants personnel appeared to prefer PAC as no solution is to be prepared as in case of alum. Bhandup water treatment plant complex, Mumbai, use Aluminium Ferric Sulphate as a coagulant, which is one of the biggest plants in India.

In many of water treatment plants is very clean having turbidity less than 10 during non monsoon period. Whenever the turbidity is so low alum or PAC is not added although the water pass through all the units such as flocculates and settling tanks before passing through rapid sand filters. In certain water treatment plants non mechanical devices such as hydraulic jumps are being used for mixing of chemicals. In some cases, paddles of flash mixer were not in working condition.

### 7.3 Clarifier

Clarifier sludge samples from many of the water treatment plants were collected and analyzed. Analysis results are given in **Table 7.3**. Analysis results shows that mostly clarifier sludge exceeds general standard (Suspended Solids 100 mg/l and BOD 30 mg/l), therefore, there is a need to have a mechanism to make it fit before disposal. Sludge may be dewatered and disposed safely, inconformity with existing guidelines. Modes of disposal of clarifier sludge and filter backwash waters are given in **Table 7.4**. Clarifier sludge should be properly dewatered and disposed off.



**Table 7.1: Raw water quality of Selected Water Treatment Plants**

Sl. No	Location	Name of water treatment plants	Source	pH	Turbidity	Alkalinity (as CaCO <sub>3</sub> )	Hardness (as CaCO <sub>3</sub> )	Cl <sup>-</sup>	So <sub>4</sub> <sup>-</sup>	NO <sub>3</sub> <sup>-</sup>	MPN
1.	Ahmedabad	Kotarpur	Narmada & Mahi River	8 - 8.9	1.2 - 232	-	-	-	-	-	
2.	Bhopal	Kolar	Kolar River	7.6 - 8.7	8.0 - 81	124 -155	121-149	8-10	4.5-9.9	0.15 -1.25	920-2400
3.	Bhopal	Narayangiri Hill	Upper Lake	7.6-8.4	3.9 - 35.4	92-144	68-106	16-30	-	-	2400
4.	Bhopal	Pulpukhta	Upper Lake	7.0 - 8-5	4.0 - 16.2	-	-	-	-	-	2400
5.	Bhubneshwar	Bhubneshwar	Khakhai River	7.1-7.9	2.8 - 335	-	-	-	-	-	-
6.	Bhubneshwar	Mundali	Mahanadi River	-	10 - 350	-	-	-	-	-	-
7.	Delhi	Wazirabad	Yamuna River	7.7-8.8	6 – 8000	88 - 220	92 – 210	5 – 348	12 - 48	0 - 4	24x10 <sup>7</sup> 25x10 <sup>2</sup>
8.	Delhi	Haiderpur	Yamuna River	7.8-8.0	50 - 2295	67-95	85-128	6 - 8	11.8-30.3	0.22-4.62	80*10 <sup>3</sup> - 103*10 <sup>4</sup>
9.	Indore	Mandleshwar	Narmada River	7.7-8.8	2.5 - 8000	68-156	64-160	16-48	24-52	0-2.5	33-2400
10.	Indore	Dew Dharam	Yashwant Sagar Dam	-	30 - 2000	100-170	-	10 - 30	-	-	-
11.	Jabalpur	Narmada - Lalpur	Narmada River	7.2-7.6	6 - 5000	85-150	115-124	18-22	9.4-15	-	350-2400
12.	Jabalpur	Bhongadwar	Narmada River	7.2-7.6	6 – 5000	-	-	-	-	-	-

Sl. No	Location	Name of water treatment plants	Source	pH	Turbidity	Alkalinity (as CaCO <sub>3</sub> )	Hardness (as CaCO <sub>3</sub> )	Cl <sup>-</sup>	So <sub>4</sub> <sup>-</sup>	NO <sub>3</sub> <sup>-</sup>	MPN
13.	Jabalpur	Ranjhi	Pariat Tank	6.5-7.5	10 - 2000	-	-	-	-	-	-
14.	Kanpur	Benajhabar	Ganga river & Ganga Canal	7.7-8.0	2.3 - 78.8	120-320	45 -110	9-32	21-48	0-1.772	11*10 <sup>4</sup> -92*10 <sup>4</sup>
15.	Kolkata	Indra Gandhi	Hoogly river	7.5-8.6	18.8 - 476.8	72-172	64-159	6-16	10-35.2	0.112-0.265	2000-9*10 <sup>4</sup>
16.	Lucknow	Aishbagh	Gomti River	8-8.4	7 - 1200	-	170-260	8-26	-	0-2.0	-
17.	Lucknow	Balaganj	Gomti River	8-8.4	9.6 - 828	-	11-28.8	0.6-28	-	0-04	-
18.	Nashik	Nashik Road	Darna River	7.2-7.8	25 - 3000	40-180	146-280	24-35	-	0.30-0.64	-
19.	Nashik	Panchvati	Godavari River	7.2-7.8	25 - 300	-	-	-	-	-	-
20.	Nashik	Trimback Road	Gangapur Dam	7.3-7.8	15 - 150	80-210	80-201	12-45	-	0.16-0.80	-
21.	Pune	Parvati	Khada-Kuasla Dam	7.8-8.2	2.4 - 4.5	30-58	25-50	0.9-13	-	0.1-0.2	1800
22.	Pune	Cantonment	-Do-	7.2-7.6	5 - 60	-	-	-	-	-	-
23.	Ranchi	Swarnrekha	Swarnrekha River	7.0-7.2	30 - 2500	-	-	-	-	-	348-1609
24.	Shimla	Gumma	Nautikhad river	7.4-8.5	0.5 - 4.5	20-75	80-2060	10-47.5	-	-	-
25.	Surat	Katargam	Tapi River	7.5-8.4	0.2 - 460	106-154	58-128	24-58	-	3.58-7.10	64-2247

**Note:** Turbidity is in NTU; all the remaining parameters are in mg/l except pH.

**Table 7.2: Raw water quality of Agra Water Works (Intake)**

SI no.	Parameters	Permissible Limits as per CPCB*	Quality of Raw water							
			November 2002				December 2002			
			2.11.02	12.11.02	19.11.02	26.11.02	04.12.02	11.12.02	17.12.02	25.12.02
1	pH.	6 - 9	8.90	8.60	8.90	9.10	9.40	8.80	8.70	8.30
2	B.O.D (mg/l)	< 3	9.00	12.00	16.00	27.00	27.50	30.00	32.00	15.40
3	C.O.D (mg/l)	< 10.0	42.60	46.00	44.00	43.60	48.40	57.60	57.60	48.00
4	D.O (mg/l)	> 4	10.20	9.50	11.80	13.50	16.50	12.80	12.50	10.50
5	Chlorine Demand (mg/l)		25.60	35.40	28.80	35.40	28.30	46.00	52.60	54.80
6	MPN. Index/100ml	< 5000	240 x 10 <sup>3</sup>	240x 10 <sup>3</sup>	240x 10 <sup>3</sup>	240x 10 <sup>3</sup>	240x 10 <sup>3</sup>	240x 10 <sup>3</sup>	180x 10 <sup>3</sup>	240x 10 <sup>3</sup>

Note: \* - Standards for Class C water usage

**Table 7.3: Clarifier Sludge Samples of selected Water Works**

SI No.	Name of Water Treatment Plants / City	pH	TSS	BOD <sub>3</sub> day at 27 °C	Nitrates (as NO <sub>3</sub> )	Total Chromium (as Cr)	Hex. Chromium (as Cr)	Arsenic (as As)	Lead (as Pb)	Nickel (as Ni)	Cadmium (as Cd)	Phenolic compound	Total Iron
1	Jeevni Mandi WTPs, Agra	8.09	210	26	26.15	N.D	N.D	0.031	N.D	N.D	0.005	0.12	-
2	Sikandra WTPs, Agra	7.46	6266	366	15.47	N.D	N.D	0.39	0.014	0.01	0.02	0.59	-
3	Balaganj WTP, Lucnow	7.55	432	15	1.41	N.D	N.D	0.011	N.D	N.D	0.01	0.022	-
4	Indore City WTP, Indore	6.89	9968	512	1.51	N.D	N.D	0.293	0.005	N.D	0.02	0.145	-
5	5 MLD WTP, Bhopal	7.09	910	112	0.16	N.D	N.D	0.081	N.D	N.D	0.01	0.406	-
6	Mundali WTPs, Bhubaneshwar	8.30	11668	1612	0.25	N.D	N.D	0.27	0.67	0.82	0.09	N.D	-
7	Rukka Filtration Plant, Ranchi	8.42	4840	295	0.56	N.D	N.D	0.03	0.19	N.D	0.14	N.D	-
8	Kotarpur WTP, Ahmedabad	7.15	1178	34	0.96	N.D	N.D	N.D	0.07	N.D	0.23	N.D	-
9	Kotargam, Water Works, Surat	6.98	29050	450	1.52	N.D	N.D	0.21	0.15	0.38	0.11	ND	-
10	Bhandup WTPs, Mumbai	6.85	736	40	0.71	N.D	N.D	N.D	0.04	0.05	0.11	N.D	-
11	T.K Halli , Bangalore	7.75	492	15	0.35	N.D	N.D	N.D	0.02	N.D	0.08	N.D	-
12	Aruvikkara WTP, Bangalore	7.0	30764	930	34.52	N.D	N.D	0.007	0.09	N.D	0.01	N.D	-
13	Indira Gandhi WTP, Kolkata	8.1	208	8	0.45	N.D	N.D	0.04	0.08	N.D	0.03	N.D	-
14	Ashok Nagar WTP, Kurnool	7.1	2680	54	4.15	N.D	N.D	0.04	0.08	N.D	0.27	N.D	-
15	Peddapur Ph.IV, Hyderabad	8.1	1056	48	1.31	N.D	N.D	N.D	0.06	N.D	0.15	N.D	-

**Note:** All Parameters are in mg/l except pH; N.D: Not Detectable

**Table 7.4: Disposal of Filter Backwash water and Clarifier sludge at various Water Treatment Plants**

S. No	City	Capacity (MLD)	Name of WTPs	Mode of disposal
1	Abohar	11.4	City Water Works	The filter backwash water and sludge is disposed off in the abandoned S & S tank
2	Abohar	22.7	New Water Works	The backwash water from filters and sludge from sedimentation tank is collected in a circular tank and then pumped & disposed in area near the canal.
3	Agra	250	Jeevni Mandi Water Works	Filter backwash water and clarifier sludge quantity is about 5 to 10% of treated water. Filter back wash water and sludge is discharged into down stream of intake in Yamuna river
4	Agra	144	Sikandra Water Works	The most unusual thing at Sikandra water treatment plant is that filter backwash water and clarifier sludge are discharged on up stream side of Intake of water treatment plant.
5	Ahmedabad	650	Kotarpur WTP	Quantity of filter backwash water is 2 to 3% which is re-circulated to inlet / day. Sludge from clarifier 0.2 to 0.3% in normal season and 0.4 to 0.7% in monsoon season. These are disposed off in the drain.
6	Ambala	19.5	Canal Water Works	Quantity of filter backwash water is about 4% and sludge wash water is disposed in drain and sludge is disposed on land.
7	Bhopal	13.6	Pulpukhta filtration plant	The filter backwash water is 1000 M <sup>3</sup> / day, discharged to the drain
8	Bhopal	22.7	Narayangiri Hill Birla Mandir	Quantity of filter backwash water and clarifier sludge is about 3%. These are used for gardening.
9	Bhopal	35.8	Kolar Water Treatment Plant	The Filter backwash waters and clarifier sludge are disposed off through combined drain. Total quantity is 2% in normal day and increases up to 4% during heavy rain day.
10	Bangalore	300	Thore Kadam Halli Phase IV	Clarifier sludges are conditioned and dewatered. Filter backwash waters are discharged into the drain
11	Bhubneshwar	115	WTP at Mundali	The filter backwash water and clarifier sludge are generated about 0.1 million litre per bed units. This water discharged through the open channel at the down stream of the river Mahanadi.
12	Bhubneshwar	81.9	Palasuni Water Works	Quantity of filter backwash water and sludge is 2500m <sup>3</sup> . The backwash water and sludge discharge through pipe in nallah.

S. No	City	Capacity (MLD)	Name of WTPs	Mode of disposal
13	Chandigarh	272.4	Water Works Sec. 9	There is no measurement for sludge. The filter backwash water is 4.5 MLD, at present. Backwash water and clarifier sludge disposed off in open channel. There is proposal for reuse of filter backwash water.
14	Chennai	272.8	Kilpauk WTP	Clarifier sludge are conditioned and dewatered. Filter backwash waters are discharged into the drain.
15	Delhi	27.3	Okhla Water Works	Sludge from clarifier and filter backwash waters are let out into the drain which flows near by.
16	Delhi	545.5	Wazirabad Water Works	The filter backwash water and clarifier sludge is 10% of treated water, Backwash water and clarifier sludge are discharged in Yamuna River by gravity on down stream side.
17	Delhi	454.6	Haiderpur I plant	Quantity of filter backwash water and clarifier sludge is about 8 to 10%.
18	Hyderabad	150.0	Paddapur WTP Phase-IV	Sludge are collected separately and discharged in a nallah which ultimately joins Manjira river. Filter backwash water are collected and fed at the Inlet of WTP
19	Hyderabad	118.2	Asif Nagar WTP	Sludge from clarifier and filter backwash water are collected in the tank and then pumped to separate settling tank, after adding alum at the rate of 150 kg/day. After sedimentation the water is passed through a separate rapid gravity filter and mixed with the treated water.
20	Indore	45.5	Dew Dharam Filtration Plant	The filter backwash water and sludge are used for gardening. There is a combined drain for filter backwash water and sludge
21	Indore	182.0	Narmada - Mandleshwar	Quantity of filter backwash water and clarifier sludge is 9 MLD (4.5 MLD each unit). There is a combined drain for back wash water and sludge. These are used for irrigation purposes. In monsoon season there is a problems of excess sludge.
22	Jammu	65.6	Sittlee	The filter backwash water and clarifier sludge is directly disposed on the down stream side of the river. Filter back wash water is 2000 m <sup>3</sup> /day for Avg.6 filters. De-sludging quantity 20% during dry season and 30% during monsoon season.
23	Jammu	9.0	Tawi Filtration Plant	The filter backwash water and sludge is disposed off in the Tawi river at down stream side of intake. Quantity of back wash water is 450 m <sup>3</sup> /day
24	Jabalpur	41.0	Narmada Water Supply	Filter backwash waters and sludge are discharged into near by drain which joins

S. No	City	Capacity (MLD)	Name of WTPs	Mode of disposal
			Lalpur	Narmada river on the downstream side on the intake.
25	Jabalpur	54.6	Ranjhi WTP	The filter backwash waters are 2250 m <sup>3</sup> /day and sludge from clarifier 1125 m <sup>3</sup> / day. The filter backwash water and sludge is discharged into a tank near WTP.
26	Jabalpur	27.3	Bhongadwar	The filter backwash water is up to 900 m <sup>3</sup> per day and clarifier sludge is upto 450 m <sup>3</sup> per day. Filter backwash water and sludge is discharged into nallah (drain) which is behind the water treatment plant.
27	Kanpur	3.5	Benajhabar WTP	Quantity of filter backwash water is less than 2%. The backwash water is directly discharged into trunk sewer. The plain settling tanks are cleaned occasionally.
28	Kota	165.0	Akilgarh WTP	Filter backwash water and clarifier sludges from all the WTPs are discharged in to Chambal river at down stream of Intake.
29	Kolkata	909.2	Indira Gandhi WTP	There are no measurements of filter backwash water and clarifier sludge. The sludge from clarifier 272.76 MLD is disposed off in the down stream of Hoogly river. The sludge from settling tanks are dried and sold for the manufacture of bricks. Filter backwash water is disposed off in the down stream of Hoogly river
30	Lucknow	220	Lucknow - Aishbagh.	The filter backwash water is directly discharged into the sewerage system. Quantity of filter backwash water is about 10%.
31	Lucknow	96	II Water Works, Balaganj	Quantity of filter backwash water and clarifier sludge is about 10% .The filter backwash water is taken to the separate settling tank and then settled water is taken to the inlet of flocculation tank. The sludge from settling tank is removed everyday by opening the valve placed at the bottom of these tanks during backwashing the filters when the raw water is not entering the settling tanks.
32	Mumbai	2060	Bhandup WTP, Vihar	Quantity of filter backwash water is about 2% which is disposed off in vihar Lake.
33	Mysore	143.2	Hogan Halli second stage	Filter backwash water and clarifier sludges are discharging into the drain
34	Mysore	50.0	Ramman Halli WTP	Filter backwash water and sludge from clariflocculator goes to a lake nearby. (Ramanhalli lake)
35	Nashik	47.0	Panchwati Filtration Plant	Filter backwash waters and clarifier sludges are disposed into the drain.

S. No	City	Capacity (MLD)	Name of WTPs	Mode of disposal
36	Nashik	81.0	Trymback road filtration plant	Quantity of filter backwash water is 20 to 25 lacs liter per day and clarifier sludge is not measured. Back wash water and sludge are directly discharge into corporation drain which meets the river Godavari.
37	Nashik	49.7	Nasik road filtration plant	Filter backwash water and clarifier sludges are disposed into the near by storm water drain.
38	Pune	260.0	Cantonment Water Works (P.M.C)	The filter backwash water is discharged into canal and clarifier sludge are discharged into the drain.
39	Pune	545.0	Parvati Water Works	The filter backwash water and clarifier sludge is discharged into the drain.
40	Ranchi	113.7	Swarnrekha Water Supply	Quantity of filter backwash water is about is 2.3 MLD and clarifier sludge quantity is about 3.2 MLD. Back wash water and sludge discharged through a channel at the down stream of Swarnrekha river.
41	Ranchi	19.5	Gonda Hill Water Works	There is no measurement for Clarifier sludge. The filter backwash water is 2% of the filtered water. Back wash water and sludge disposed off in the down stream of river Potpotto.
42	Ranchi	56.8	Hatia Filtration Plant	The filter backwash water quantity is 2%. The filter backwash water and clarifier sludge is disposed in to the drain which is used for the irrigation purposes .
43	Shimla	16.3	Old Gumma WTP at Gumma	The filter backwash water is discharged through the drain on down stream of Nauti khad.
44	Shimla	10.9	New Gumma WTP	Filter backwash water is directly disposed to the Nauti khad river.
45	Shimla	10.8	Ashwani khad WTP	The filter backwash water and sludge is disposed off in the river
46	Shimla	9.3	Dhalli WTP	The filter backwash water is discharged into drain which meets Churat spring at the down stream of intake. Sedimentation tanks are cleaned by emptying after rainy season and the sludge is disposed off on near by Open Land.
47	Surat	240.0	Katargam Water Works	Quantity of filter backwash water is 300m <sup>3</sup> per backwash and disposed off on the down stream of Tapi River . Dirty water sump is provided for reuse of backwash water which is not being used
48	Surat	68.0	Head Water Works	Filter Backwash water quantity is upto 2 MLD. Filter backwash water and clarifier sludge disposed off in the downstream of the Tapi River
49	Trivandrum	36.0	Wellington	The filter backwash water and clarifier sludge is



S. No	City	Capacity (MLD)	Name of WTPs	Mode of disposal
			water works	discharged into the lake through the canal.
50	Trivandrum	86.0	Aruvikkara WTP	The filter backwash water and clarifier sludge are disposed off in to the downstream side of the river.

#### 7.4 Filter Backwash

Filter back wash water samples from many of the water treatment plants were collected and analyzed. Analysis results are given in **Table 7.5**. It can be seen that some of the samples have rather high BOD. The quantity of filter backwash water is normally about 5%. It can easily be recycled to the inlet of water treatment plant, as about 20 times dilution would be available at the inlet. This is being practiced at Peddapur water treatment plant, Hyderabad.

Filter backwash waters should be recycled to conserve water. Analysis results show that often filter backwash waters exceed general disposal standards. This emphasizes the need for treatment before disposal. Reuse of filter backwash waters, which already being practiced, shall be explored by other water treatment plants.

#### 7.5 Chlorinators

Mostly, water treatment plants are provided with vaccum type chlorinators; while Chandigarh water treatment plant has a gravity type chlorinator. Water treatment plants at Ambala, Abohar, Jammu and Shimla were using bleaching powder for the chlorination. In some of water treatment plants, chlorinators were not functioning and chlorine was being added just on the basis of guess work / experience. Chlorinators in many water treatment plants were found to be out of order and excessive chlorine was being used.

#### 7.6 Chemical usage & Consumption

In most of the plants, orifice type device was being used for feeding alum. However, alum feeding arrangement had got corroded / damaged and alum was being added by guess work. This was the case particularly for smaller water treatment plants and those maintained & operated by municipalities.

Of the 52 water treatment plants visited, only Okhla water treatment plant at Delhi is using ozonation. Here ozonation is being done for oxidizing iron, as water source is rainy wells, which contain iron.

**Table 7.5: Results of Filter Backwash Water Samples from Water Treatment Plants**

SI No.	Name of Water Treatment Plants / City	pH	TSS	BOD3 day at 27 deg.C	Nitrates (as NO3)	Total Chromium (as Cr)	Hex. Chromium (as Cr)	Arsenic (as As)	Lead (as Pb)	Nickel (as Ni)	Cadmium (as Cd)	Phenolic compound	Total Iron (as Fe)
1	Jeevni Mandi WTPs, Agra	7.76	207	24	28.45	N.D	N.D	0.017	N.D	N.D	0.005	0.09	-
2	Sikandra WTPs, Agra	7.6	428	65	25.32	N.D	N.D	0.10	N.D	N.D	0.01	0.03	-
3	Okhla WTP 4 MGD Low Nitrate, Delhi	7.99	284	46	5.73	N.D	N.D	0.35	0.19	0.03	0.03	0.88	41.5
4	Okhla WTP 6 MGD High Nitrate, Delhi	7.72	785	33	17.09	N.D	N.D	1.25	0.02	0.04	0.01	0.055	73
5	Benajhwar WTP, Kanpur	7.28	2826	98	2.19	N.D	N.D	0.061	0.002	N.D	0.01	0.146	-
6	Ranjhi WTP, Jabalpur	7.32	3164	68	0.31	N.D	N.D	0.003	N.D	N.D	0.005	N.D	-
7	Lalpur WTP, Jabalpur	7.17	1112	32	1.56	N.D	N.D	0.003	N.D	N.D	0.005	N.D	-
8	Aish Bagh WTP, Lucnow	7.69	1472	30	1.56	N.D	N.D	0.009	N.D	N.D	0.07	0.033	-
9	Balaganj WTP, Lucnow	7.6	2166	67	2.37	N.D	N.D	0.019	N.D	N.D	0.01	0.013	-
10	Bhongadwar WTP, Jabalpur	7.72	690	26	1.51	N.D	N.D	0.002	N.D	N.D	0.04	0.199	-
11	Indore City WTP, Indore	7.18	510	23	1.67	N.D	N.D	0.017	N.D	N.D	0.01	0.15	-
12	Narmada -Mandleshwar WTP for Indore	7.58	1474	46	0.36	N.D	N.D	0.001	N.D	N.D	0.2	0.516	-
13	Katar WTP, Bhopal	7.90	1018	21	4.17	N.D	N.D	0.001	N.D	N.D	0.08	0.056	-
14	64 MLD WTP, Kota	7.09	592	41	0.21	N.D	N.D	0.005	N.D	N.D	0.005	N.D	-
15	Gumma WTP, Shimla	8.1	86	7	2.4	N.D	N.D	0.001	N.D	N.D	0.04	N.D	-
16	Mundali WTPs,Bhubaneshwar	6.95	2804	92.5	1.52	N.D	N.D	N.D	0.05	N.D	0.17	N.D	-
17	Rukka Filtration Plant, Ranchi	6.75	462	64	3.29	N.D	N.D	0.03	0.04	0.10	0.08	N.D	-
18	Kotarpur WTP, Ahmedabad	7.35	532	10	0.10	N.D	N.D	N.D	0.10	N.D	0.30	N.D	-
19	Kotargam, Water Works, Surat	6.95	1280	140	1.26	N.D	N.D	N.D	0.03	0.05	0.13	N.D	-
20	Bhandup WTPs, Mumbai	6.80	270	12	0.20	N.D	N.D	N.D	0.06	N.D	0.04	N.D	-
21	Hogan Halli WTP, Mysore	7.16	530	15	2.88	N.D	N.D	N.D	N.D	N.D	0.02	N.D	-
22	T.K Halli 300 MLD WTP,Banglore	7.70	822	30	1.62	N.D	N.D	N.D	N.D	N.D	0.02	N.D	-
23	Aruvikkara WTP, Banglore	6.60	2008	90	6.38	N.D	N.D	0.005	0.04	N.D	0.01	N.D	-
24	Indira Gandhi WTP, Kolkata	7.48	5120	100.0	0.20	N.D	N.D	0.05	0.10	N.D	0.13	N.D	-
25	Ashok Nagar WTP, Kurnool	7.54	484	22.0	4.81	N.D	N.D	0.02	0.03	N.D	0.16	N.D	-
26	Peddapur Ph.IV, WTP Hyderabad	8.25	362	24.0	0.76	N.D	N.D	N.D	0.04	N.D	0.19	N.D	-
27	Asif Nagar WTPs, Hyderabad												
	(i) Mixed sludge and backwash water	6.96	32	1.0	1.97	N.D	N.D	N.D	N.D	N.D	0.16	N.D	-
	(II) Treated mixed sludge & backwash	7.20	8	1.0	1.62	N.D	N.D	N.D	N.D	N.D	0.16	N.D	-

**Note:** All Parameters are in mg/l except pH. , N.D : Not Detectable

Average annual chemical consumption for various water treatment plants is given in **Table 7.6**. It can be seen that chemicals used were alum and chlorine. Lime was used in few cases only. In certain cases, raw water turbidity is high during monsoon; corresponding alum consumption was also high. Alum dose ranges for monsoon and non monsoon for some of the water treatment plants are given at **Table 7.7**. It reveals that there are many folds increase in alum dose during monsoon period in comparison to non monsoon period due to high turbidity. This also means more sludge generation.

## **7.7 Operation & Maintenance of Water Treatment Plants**

Operation and maintenance of large capacity water treatment plants of metropolitan towns and where operation and maintenance is being done by private organizations is satisfactory. However, O&M conditions in some of the water treatment plants operated by Public Health Engineering Departments and municipalities are quite unsatisfactory. Repair of equipment is not done timely for lack of funds and interest.

In the same state, some of the water treatment plants are excellent from O&M and data keeping point of view where as conditions of some of the water treatment plants is rather bad. Interaction between several towns of same state should be established so that all the water treatment plants function well. Knowledge of formation of Trihalomethanes (THMs) due to chlorination of organic matter in water appeared to be absent in many instances. Many water treatment plants did not have post of chemist which is a must for all water treatment plants irrespective of its capacity.

## **7.8 Conclusion & Recommendations**

Main conclusions and recommendations emerging from study are as follows:

- Surface water is the predominant source of raw water for all water treatment plants. To large extent water treatment plants have their water source nearby, whereas Ahmedabad, Bangalore, Chennai, Delhi, Hyderabad and Mumbai have their source far away from the city.
- In general, conventional treatment is provided having a sequence of alum addition, coagulation, flocculation, sedimentation, filtration and disinfection by chlorination.

**Table 7.6: Chemical Consumption for various Water Treatment Plants**

SI no.	Name of Water Treatment Plants	Water Treated (MLD)	City	Alum Consumption (MT/Y)	Chlorine (MT/year)	Alum dose mg/l	Chlorine mg/l		Lime Consumption (MT/Y)
							Pre	Post	
1	Canal Water Works	10.5	Ambala	42.0	24.0	11.0		2.0	
2	Water works sec.9	204.6	Chandigarh	616.9	108.0	8.3		1.4	
3	Old Gumma WTP	13.1	Shimla	25.0	16.0	5.2		3.3	
4	New Gumma WTP	8.7	Shimla	15.0	10.0	4.7		3.1	
5	Ashwani Khad WTP	7.6	Shimla	15.0	10.0	5.4		3.1	
6	Dhalli WTP	8.4	Shimla	30.6	4.0	10.0		1.3	
7	City water works	11.4	Abohar	48.0	4.4	11.5		1.1	
8	New water works	11.4	Abohar	52.8	9.1	12.7		2.2	
9	Okhla water works	27.3	Delhi	-	80.0	-		8.0	
10	Haiderpur WTP	470.0	Delhi	4306.2	490.8	25.1		2.9	
11	Benajhabar WTP	230.0	Kanpur	1614.2	530.0	19.2			
12	Lucknow Jal Sanstanaishgabh	220.0	Lucknow	1555.4		19.4	0.7	3.0	
13	II water works Balaganj	90.0	Lucknow	731.7		20.9	1.7	2.8	
14	Pulpukhta Filtration plant	11.4	Bhopal	56.4	17.5	13.6			
15	Narayan giri Hill WTP	22.7	Bhopal	109.5	22.5	13.2		2.7	
16	Kolar WTP	162.8	Bhopal	878.6	120.0	14.8		2.0	28.3
17	Narmada water supply Lalpur	47.0	Jabalpur	525.2	35.0	30.6		2.0	30.0
18	Ranjhi WTP	27.3	Jabalpur	270.0	25.0	27.1		2.5	
19	Bhongadwar WTP	27.3	Jabalpur	150.0	25.0	15.1		2.5	
20	Dew Dharam Filtration Plant	25.0	Indore	350.0	130.0	38.4		4.9	
21	Narmada water supply Project Mandleshwar	182.0	Indore	800.0	130.0	12.0		2.0	

SI no.	Name of Water Treatment Plants	Water Treated (MLD)	City	Alum Consumption (MT/Y)	Chlorine (MT/year)	Alum dose mg/l	Chlorine mg/l		Lime Consumption (MT/Y)
							Pre	Post	
22	Cantonment water works(P.M.C)	250.0	Pune	1100.0	133.0	12.1	0.4	1.0	
23	Parvati water works	450.0	Pune	1350.0	378.0	8.2	1.0	1.3	
24	Panchwati Filtration plant	56.0	Nasik	540.0	57.0	26.4		2.5	
25	Trymback road filtration plant	113.6	Nasik	1222.6	133.0	29.5		2.5	
26	Nasik road filtration plant	32.6	Nasik	165.8	31.5	13.9	-	2.6	
27	Swarnrekha water supply project	109.1	Ranchi	900.0	162.0	22.6		4.1	350.0
28	Gonda Hill water works	72.7	Ranchi	292.0	26.3	11.0		1.0	146.0
29	Hatia WTP	56.8	Ranchi	281.5	25.5	13.6		1.2	112.4
30	Indira Gandhi WTP	818.3	Kolkata	4781.9	437.1	16.0		1.5	
31	Bhubaneshwar- Palasuni	107.0	Bhubanshwar	688.0	193.0	2.7		0.8	219.0
32	Mundali WTP	115.0	Bhubanshwar	707.2		16.8	1.0	3.0	236.9
33	Kotarpur WTP	300.0	Ahmedabad	55.0	220.0	0.5			
34	Katargam water works	260	Surat	404.2	529.8	4.3		5.6	
35	Head water works Varacha road	68.0	Surat	89.9	71.7	3.6		2.9	
36	Bhandup WTP	2060	Mumbai	30000.0	1058.0	39.9		1.4	
37	Wellington water works	36.0	Trivandrum	164.3	21.9	12.5		1.7	109.5
38	Kilpauk WTP	100.0	Chennai	1460.0	-	40.0	20.0	30.0	
39	Thore Kadam Halli WTP Phase IV (Degreement Plant)	300.0	Bangalore	52.6	438.0				
40	Paddapur WTP phase-IV	150.0	Hyderabad	250.0	100.0	4.6		1.8	
41	Asif Nagar WTP	118.2	Hyderabad	700.0	85.0	16.2		2.0	
42	Ashok Nagar filter bed	45.5	Kurnool	150.0	96.0	9.0		5.8	

**Table 7.7: Alum Dose during Monsoon and Non - Monsoon Season**

S. No	Name of Water Treatment Plants	City	Water Treated MLD	Alum MT/Y	Average Alum mg/l	Alum mg/l monsoon range	Alum mg/l Non monsoon range
1	City Water Works	Abohar	11.4	48.0	11.5	20 -33	5 - 12
2	New Water Works	Aobhar	11.4	52.8	12.7	15 – 20	10 - 14
3	Canal Water Works	Ambala	10.5	42	11	40 – 45	4.1 – 5.5
4	Pulpukhta Filtration Plant	Bhopal	11.4	56.4	13.6	50 – 60	8 -12
5	Kolar Water Treatment Plant	Bhopal	162.8	878.6	14.8	18 – 22	10 -15
6	Narayan Giri Hill	Bhopal	22.5	109.5	13.2	25 – 40	10 -18
7	Water Works Sec. 39	Chandigarh	204.6	616.9	8.3	10 – 15	4 - 10
8	Narmada Water Supply Lalpur	Jabalpur	47	525.2	30.6	60 – 80	0 - 40
9	Ranjhi Water Treatment Plant	Jabalpur	27.3	270	27.1	60 – 70	5 - 20
10	Benajhabar WTP	Kanpur	230	1614.2	19.2	25 – 40	10 - 20
11	Indra Gandhi WTP	Kolkata	818.3	4781.9	16.0	22 – 32	5 - 15
12	Lucknow Jal Sansthan Aishbagh	Lucknow	220	1555.4	19.4	50 – 80	1 - 22
13	Ilnd Water Works Balaganj	Lucknow	96	731.7	20.9	50 – 86	5 - 22
14	Nashik Road Filtration Plant	Nashik	32.6	165 - 8	13.9	25 - 35	0 – 18
15	Panchvati Filtration plant	Nashik	56	540.2	9.6	30-60	10-20
16	Trimback Filtration Plant	Nashik	113.6	1222.6	29.5	50-65	10-25
17	Parvati Water Works	Pune	450	1350	8.2	5-20	4-6
18	Contonment Water Works	Pune	250	1100	12.1	25-35	3-10
19	Hatia Water treatment	Ranchi	56.8	281.5	13.6	36-46	2-17
20	Dhalli WTP	Shimla	8.4	30.6	10	12-15	8-10
21	Katargam Water Works	Surat	260	404.2	4.3	16-20	1-15

- The study revealed that there is no uniform or set pattern of operation and maintenance of water treatment plants. Even record keeping differs from plant to plant. While some water treatment plants are very well maintained and operated, in many cases situation was far from satisfactory.
- Alum is being added as coagulant in almost all the water treatment plants, except in few recent plants, where Poly Aluminium Chloride is used. Bhandup complex, Mumbai is using Aluminium Ferric Sulphate.
- In monsoon season, maximum alum dose ranges from 60 to 80 mg/l for Lalpur water treatment plant, Jabalpur and minimum ranges from 5 to 20 mg/l for Parvati water treatment plant, Pune.
- Alum dosing equipments was found to be not working in many water treatment plants. It should be ensured that alum dosing equipment remains functional throughout the year and only requisite dose of alum is added which should be worked out through jar tests at set frequency.
- Algae growth was not significant in case of rapid sand filters. However, in case of open filters having direct sunlight, frequent cleaning of filter bed walls to remove algae is required.
- Study reveals that filter backwash water and clarifier sludge of water treatment plants need to be treated before discharge. Recycling of filter backwash water which is being followed in some of the water treatment plants should be encouraged and it may be explored in case of all other water treatment plants, as it would result in conservation of water.
- Central Pollution Control Board developed technology for recovery and reuse of the alum used for clarification, which is under execution for viability of pilot scale. This technology shall be examined for cost optimization and to reduce the burden on safe disposal of sludge.
- As the wastes from water treatment plants are generally not meeting requirement of 30 mg/l BOD and 100 mg/l Suspended Solids. It is suggested that sludge and filter back wash water should be treated and properly disposed. Water treatment plant authorities may also take consent from the State Pollution Control Boards / Pollution Control Committees and ensure treatment & disposal of water treatment plant rejects.

- Almost all the water treatment plants are using liquid chlorine for pre & post chlorination, except few, which are using bleaching powder. Pre chlorination dosage of 60 mg/l at Sikandra water treatment plant, Agra is attributed to high organic load in raw waters. Use of pre chlorination may be avoided due to possibility of formation of Tri halo methane. Use of ozone, copper sulphate, potassium permanganate etc. may be explored thorough R & D activity wherever algae problem is faced or contamination of water source is suspected.
- In many cases, chlorination was not found functioning at the time of visit resulting in excessive use of chlorine. This causes chlorine leakage and corrosion of water treatment plant equipment and structure, therefore, a mechanism, similar to that of the boiler inspectors is to be established to ensure proper functioning of chlorinators.
- Water treatment plant operators should be provided regular training. Proper database of operation & maintenance of water treatment plant should be prepared and efficient Management Information Systems (MIS) should be developed to cater to all the activities of water treatment plants.
- Outcome of the study were discussed in 51<sup>st</sup> Conference of Chairmen and Member Secretaries of State Pollution Control Boards (SPCBs) / Pollution Control Committees (PCCs) held during February 14-15, 2005. The minutes of the Conference are as follows:
  - ⇒ This is a high priority item as the implications are very significant from Public Health point of view and has failed to receive the attention that it deserves from the SPCBs.
  - ⇒ The SPCBs / PCCs to carefully go through the findings of the study carried out by CPCB of Water Treatment Plants and implement the recommendations
  - ⇒ It was also decided in the Conference that SPCBs & PCCs has to implement the recommendations of the study and also inspect the water treatment plants at regular interval in accordance with the functions laid down under Section 17(f) of the Water (Prevention and Control of Pollution) Act, 1974.
- Subsequently, all the regulatory authorities were requested to take up inspections of water treatment plants as a regular exercise to improve their functioning and requested to intimate the status of water treatment plant to Central Pollution Control Board on regular basis.



**QUESTIONNAIRE**

- 1. Name of the City :
- 2. Population :
  - As per Year 1991 :
  - As per year 2001 :
- 3. Name and year of establishment of WTP :
- 4. Treatment Plant Installed Capacity : MLD
  - Quantity of water treated : MLD
- 5. Whether water treatment plant is adequate to meet present demand : Yes No
- 6. Source of Water Supply (please name the sources) :
  - River :
  - Lake :
  - Ground water :
- 7. Type of Treatment : Yes No
  - Disinfections only by bleaching power / liquid chlorine :
  - Sedimentation + Disinfection :
  - Sedimentation + Filtration + Disinfection :
  - Any other unit process, please specify :
- 8. Plans for additional water treatment plant if any

## Annexure -2

## POSTAL RESPONSE TO QUESTIONNAIRE

Sl No	Name of Town	Population (2001)	WTP Capacity		Year of installation	Water Source	Type of treatment		Plans for additional WTPs, if any	LPCD *
			Installed (MLD)	Water Treated (MLD)			Only Disinfection	Sedimentan. +Filtration +Disinfection		
<b>STATE: ANDRA PRADESH</b>										
1	Vijayawada	850,000	95.5	95.5	-	Krisna River Bores	-	Yes	Yes 36.4 MLD	112.3
2	Guntakal	117,403	4.83	4.83		1.GBC Canal 2.Borewells	-	Yes	Water Supply schemetor Rs 17 crores	41.1
3	Rajahmundry	357,336	44.50	42.00	1964	River	-	Yes	12 MLD	117.5
4	Khammam	160,500	18.16	18.16	1952	Munneir River	-	Yes	-	113.2
5	Nizamabad	2,860,000	15.91 3.27 8.18	9.09 1.82 4.09	1978 1935 1965	Alisagar Tank Manehappa Tank Raghunath Tank	-	Yes	No	52.4
6	Mahaboob Nagar	1,39,280	18.18	18.18	2000	Ramanpad Tank,Jurala Project Left canal	-	yes	No	130.5
<b>STATE: ASSAM</b>										
1	Dibrugarh Namrup Unit (HFCL)	18,000	94	36	1966 - I 1975 - II 1986 - III	Dilli River	-	Yes	No	200.0
2	Tinsukia	15,000	1.00 0.50	0.80 0.40	-	-	-	Yes	No	80.0
3	Silchar	200,000	22.7	15.35		River Barak Surface	-	Yes	No	76.75
<b>STATE: BIHAR</b>										
1	Bhagalpur	360,000	17.1	4.50	1885	Ganga	-	Yes		12.5
2	Ramgarh Cantt	73203	9.00	2.00	-	River	-	Yes	No	273
<b>STATE : GUJARAT</b>										
1	Bharuch	148,391	22.5	12 to 17	1979	Narmada River	-	Yes	No	97.7
2.	Rajkot	970,600	135	135.00	1989 1999	Bhadar Ajionyari river or lake	-	Yes	No	139.1

Sl No	Name of Town	Population (2001)	WTP Capacity		Year of installation	Water Source	Type of treatment		Plans for additional WTPs, if any	LPCD *
			Installed (MLD)	Water Treated (MLD)			Only Disinfection	Sedimentan. +Filtration +Disinfection		
3	Surat	25 lacs	18 18 32 120 120 120	16 15.00 36 220	1959 1994 1995 1997 2000 2001	Tapi	-	Yes	Sarhana Water works in feature katargam in feature Rander water works 200 MLD The works is in progress	114.8
4.	Navsari	134,000	36	15.0	1999	Kaksapur	-	Yes	No	111.8
5.	Bhavnagar	500,000	-	-	Before 1947		-	-	Under progress	
6	Porbandar	133,085	13	6.50	1962-63	Khambhaka & Fadara Dam	-	Yes	Proposed for New Double Capacity	48.8
7.	Gandhi Nagar	200,000	20.0	20.0	-	Sabarmati River	-	Yes	No	100.0
8.	Anand	132,542	-	-	-	G/W	Liquid Chlorine	yes	No	
9.	Jam Nagar	519,000	27 16 25 20	45	1963 1990 1999 1999	Rangit Sagar Dam	-	Yes*		86.7
10.	Rajkot	10 lacs	38-60 32-25 50-60 13-65 134-50	140.06	1962 1977 1989 2000	River (1) Bhadar Nyari - I&II, Lake Lalpari, Randarda	-	Yes	155MLD	140.0
11.	Valsad	70,000	11.0	11.0	1964	Auranaga River	-	Yes	No	157.1
12.	Wadhwan	63,411	9 MLD	9 MLD	-	Dholidhaja Dam	-	Yes	No	141.9
13.	Verowal	141,207	3 MLD		-	Hiran/Umreth Hire dam II	-	Yes	No	21.2
<b>STATE: KARNATAKA</b>										
1.	Davangere	3,63,570	25.0	25.0	1972	T.B River Badra Canal Borewell	-	Yes	Second stage water supply	68.8

Sl No	Name of Town	Population (2001)	WTP Capacity		Year of installation	Water Source	Type of treatment		Plans for additional WTPs, if any	LPCD *
			Installed (MLD)	Water Treated (MLD)			Only Disinfection	Sedimentan. +Filtration +Disinfection		
2.	Belgaum	5 lakhs	40.9	40.9	1962 +1985	Rakaskopp & Hidkala	-	Yes	3 MGDx2 Nos	81.8
3.	Mandya		11.00 175	7 17	1985 2001	Cauvery river	-	Yes	No	176.2
4	Hassan	121,918	21.5	11.35	1982 & 1999	Hemavathy reservoir/Borewells with power pumps 90 Nos	-	Yes	No	93.1
5	Gulbarga	430,108	11.37 9.09 25.00	11.37 9.09 25.00	1970 1978 1993	Bhima River Tube wells/ Bhosga Reservoir	-	Yes	11.2 MLD  18.16 MLD	105.7
6.	Udupi	1,27,060	Bendoor 9.08MLD Panamdur -20MLD	29.08	-	Swarna River	-	Yes	Additional WTP being handled by K.U.I.D.F.C	228.9
7.	Tumkur	2,48,590	30.0	30.0	1999	Hemavathy	-	Yes	No	120.7
8.	Shimoga	274,105	34.05	34.05	1997	River Tunga Tunga Reservoir / Gajanur	-	Yes	Additional 13.62 MLD	124.2
9.	Raichur	2,08,000	Devasugur- 3.60 Rampura- 18.16	1.80  11.35	Devasugur -1936 Rampura - 1976	Devasugur Krishna River Rampura Tungabhadra Left bank canal	-	40 MLD WTP has been constructed and commissioned on trial running		63.2
10.	K.G.F.City	2,00,000	9.08	9.08	1904	Bethamangla reservoir	-	Yes	No	45.4
11.	Manglore	3,98,745	Bendoor -40.86 Panamdur - 27.24 Total- 68.10	68.10	-	Nethravathi	-	Yes	Additional WTP being handled by K.U.I.D.F.C	171.6

Sl No	Name of Town	Population (2001)	WTP Capacity		Year of installation	Water Source	Type of treatment		Plans for additional WTPs, if any	LPCD *
			Installed (MLD)	Water Treated (MLD)			Only Disinfection	Sedimentan. +Filtration +Disinfection		
12.	Mysore	8,50,000	Jewel Filter-2.27 Settling Tank-13.62 Treatment plant-36.32 Hongalli II stage -36.32 Hongalli III stage -54.48 Melapura-50.00	Jewel Filter-2.27 Settling Tank-13.62 Treatment plant-36.32 Hongalli II stage -36.32 Hongalli III stage -54.48 Melapura-50.00	Jewel-1896 Settling tank 1924 Treat. Plant -1998 Hongalli II - stage -1968 Hongalli III stage -1979 Melapura-2002	Cavery river	-	Yes	Melapura (100 MLD)	227.1
13	Hubli Dharwad (MWSS)	786000	34.05 34.05	39.02	1956 1969	Malaprapha	-	Yes	Propose to construct 73.54	49.6
14.	Gadag Betageri	154849	15.89	15.89	1992	Tungabharria River/Borewell	-	Yes	Proposed	102.6
15.	Chitra Durga	122579	9.08	9	1973	-	-	Yes	40.00 MLD WTP New Scheme IInd stage is proposed	73.4
16.	Bidar	171585	20.43	18.44	-	Manjra river	-	Yes	No	107.5
17.	Hospet	130600	22.7	17.6	WTP at TB Dam	Tungabhadra Rayabasavanna	-	Yes	No	134.8
18.	Bhadravathi Old town	115000	9.08	9.08	1977	Bhadra River	-	Yes	Under Town Add 14.00 MLD WTP	79.0
19.	Bellary	325688	40.86 10.22	38.00 10.22	1992	Tungabhadra canal HLC/LLC	-	Yes	No	148.0
20.	Bhadravathi New	46000	9.08	9.08	1996	Bhadra River	-	Yes	No	197.4

Sl No	Name of Town	Population (2001)	WTP Capacity		Year of installation	Water Source	Type of treatment		Plans for additional WTPs, if any	LPCD *
			Installed (MLD)	Water Treated (MLD)			Only Disinfection	Sedimentan. +Filtration +Disinfection		
21.	Bijapur	258,858	10 10 27.27	47.27	1972 1998 1975	Krishna River Bhutual tank	-	Yes Yes	No No	182.6
<b>STATE: KERALA</b>										
1.	Thiruvananthapuram	889191	13.5 24.00 48.00 36.00 86.00	9.00 24.00 48.00 -	- - - -	Karamana River Aruvikkara Dam " " " " " "	- Liquid Chlorine " "	Yes Yes Yes Yes Yes	No No No No No	187.8
2.	Kollam	465850	37.5	37.5	-	Sasthamcotta Lake	Liquid chlorine	Yes	No	80.5
3.	Thiruvalla Changanassery	N/A	33.0	33.0	-	Manimala River	-	Yes	No	-
4.	Alappuzha	282727	15	15	-	Borewells	Bleaching powder	Yes	No	53.1
5.	Pumpa-Sabarimala	N/A	5.0	5.0	-	Pumpa River	Liquid Chlorine	Yes	No	-
6.	Vaikom	-	9.0	-	-	Muvattupuzha	Liquid Chlorine	Yes	No	-
7.	Ernakulam	1476488	180	180	-	Periyar River	Liquid Chlorine	Yes	No	121.9
8.	Neyyattinkara	N/A	4.8	4.8	-	Neyyar Dam	Bleaching powder	Yes	No	-
9.	Vakkom - angenko	N/A	9.0	8.0	-	Vamana River	Liquid Chlorine	Yes	No	-
10.	Punalur	-	9.0	9.0	-	Kallada River	Liquid Chlorine	Yes	No	-
11.	Kottayam	299779	16.0	16.0	-	" "	Liquid Chlorine	Yes	No	53.4
12.	Kodungalloor Karumallo & Alangad	N/A	5.5	5.5	-	Periyar River	Liquid River	Yes	No	-

Sl No	Name of Town	Population (2001)	WTP Capacity		Year of installation	Water Source	Type of treatment		Plans for additional WTPs, if any	LPCD *
			Installed (MLD)	Water Treated (MLD)			Only Disinfection	Sedimentan. +Filtration +Disinfection		
13.	Thodupuzha	N/A	12	7.2	-	Thodupuzha	Liquid Chlorine	Yes	No	-
14.	Kothamangalam	N/A	4.5	4.5	-	Kothaman-galam	Liquid Chlorine	Yes	No	-
15.	Muvattupuzha	N/A	6.5	6.5	-	Muvattupuzha River	Liquid Chlorine bleaching	Yes	No	-
16.	Puthenz	N/A	7.2	5.8	-	Muvattupuzha	-	Yes	No	-
17.	Kozhikkodu	5,03,779	2.25 4.54	7.50	1965-66 1985-86	Poonoor River	-	Yes	No	14.9
18.	Thrichur	4,06,634	14.5 24 12	50.50	1961 1985 1995	Impounded reservoir of Peechi Dam	-	Yes	No	124.2
19.	Chittur	37250	6.75	5	1978 1979	Chittur Puzha	-	Yes	No	134.2
20.	Palakkad	190400	21.5	21.5	1981	Malampuzha Dam	-	Yes	No	113.0
21.	Palakkad Pudussery	49844	4.5	4.5	1976	Malampuzha Dam	-	Yes	No	90.3
22.	Nemmara	N/A	4.5	3	-	Pothudj reservoir	-	Yes	No	-
23.	Manjeri	N/A	12	8	1993	River	-	Yes	18 MLD	-
24.	Kozhikode	4,55,897	54	54	-	River	-	Yes	No	118.5
25.	Pulppally Mullankoly	36,000	2.34	2.34	2000	Kaveri River	-	Yes	No	65.0
26.	Ambalavayal	6048	2.25	2.25	1997	Kattor River	-	Yes	No	372.1
27.	Bathery+Noolpuzha	47100	4.00	4.00	1997	Muthanga River	-	Yes	No	85.0
28.	Kolancherry	213,977	13.7	10	1996	Pazhassi	-	Yes	No	46.7
29.	KannurThalassery Kannur	2,68,800 220540	36 30	22 30	1971 1998	Iritty River	- -	Yes Yes	No No	81.9 136.0

Sl No	Name of Town	Population (2001)	WTP Capacity		Year of installation	Water Source	Type of treatment		Plans for additional WTPs, if any	LPCD *
			Installed (MLD)	Water Treated (MLD)			Only Disinfection	Sedimentan. +Filtration +Disinfection		
30.	Kasargod	42240	8	4	1976	Chandragiri River	-	Yes	No	94.7
31.	Kottakkal and Panippur	80500	2.5	1	1965	River	-	Yes	No	12.4
32.	Vengara	N/A	4.5	2.2	1998	Kadalundi River				
33.	Malappuram Old	60,575	4.5	3.50	1974	River				
34.	Malappuram New plant	60575	4.5	3.75	1994	River	-	Yes	No	119.7
35.	Karipparambu	N/A	3.60	3.00	1988	Kadalundi River	-	Yes	No	-
36.	Perochayali	280676	20	11.8	1999	Karavaloor River	-	Yes	No	42.0
37.	Chelari	N/A	4.5	2.0	1997	Kadalundi River	-	Yes	No	-
<b>STATE: WEST BENGAL</b>										
1	Barisat	1,13,300	-	-	-	G/W	-	-	Nil	
2	Midnapore	1,52,810	-	-	-	River	Bleaching powder		Nil	
3	Santipur	1,38,195	-	32.7	1968	G/W	Liquid chlorine	-	No	236.6
4	Durgapur	4,85,000	31.78	31.78	1998	D.V.C Canal	' '	Yes	7 MGD capacity in at in the existing plant	65.5
<b>STATE: PUNJAB</b>										
1	Abohar	125740	33.75	33.75	-	Malookpara District Canal Based	-	Yes	No	268.4
2	Batala	147750	-	-	-	Ground Water	Bleaching Powder			
3	Bathinda	216000	9.00	9.00	-	Sirhind Canal	-	Yes	22.5 MLD allotted recently	41.7
4	Hoshiarpur	160000	-	-	-	Ground Water	-	No	No	
5	Jalandhar	771000	-	-	-	"	Bleaching Powder	No	No	



Sl No	Name of Town	Population (2001)	WTP Capacity		Year of installation	Water Source	Type of treatment		Plans for additional WTPs, if any	LPCD *
			Installed (MLD)	Water Treated (MLD)			Only Disinfection	Sedimentan. +Filtration +Disinfection		
6	Ludhiana	1,440,000	-	-	-	“	“	No	No	
7	Moga	162916	-	-	-	“	“	No	No	
8	Pathankot	210,000	-	-	-	“	“	No	No	
9	Patiala	344378	-	-	-	G/W, T/W	“	No	No	
<b>STATE : TAMIL NADU</b>										
1.	Thiruchirappalli	7,45,891	88	88	1895(MPDS 1976Turbine 1982(Collector well))	Cavery River	Bleaching Powder	-	Does not arise	118.0
2.	Thanjavur	215875	-	-	-	Vernar River coleroom river	Bleaching Powder	-	No	
3.	Thiruvannamala	130,376	12	12	1969	Thanparnai River/ semuthi-ram Eri	-	Yes	No	92.1
4.	Kumbakonam	140021	15	15	1945	G/W	Liquid Chlorine	-	No	107.1
5.	Erode	151,274	30	20	1987	Cavery River	-	Yes	No	132.0
6.	ThooThukudi	216058	-	-	-	Thamirabarani River	Bleaching Powder			
7.	Madurai City	10,46,000	71.60	68.0	1995	Vaigai River	-	Yes	-	65.1
8.	Pollachi	93500	20	15	1975 1996	Aliyar	-	Yes	No	160.4
9.	Sivakasi	72170	6.3	4.8	1991	Vaipar River	-	Yes	No	66.5
10.	Thiruppur	351501	46	44	1993	Bhavani River	-	Yes	No	125.2
11.	Dindigul	196619	10	10	1962	Lake	-	Yes	No	50.9
12.	Karur	76328	Nil	Nil	-	Arnoravathi	-	Yes	No	-
13.	Nagercovil	204000	71MLD, 10 MLD, 17 MLD	18.0	1.945, 1972, 2001	Mukkadal				

Sl No	Name of Town	Population (2001)	WTP Capacity		Year of installation	Water Source	Type of treatment		Plans for additional WTPs, if any	LPCD *
			Installed (MLD)	Water Treated (MLD)			Only Disinfection	Sedimentan. +Filtration +Disinfection		
14.	Rajapalayam	122032	8 MLD	8 MLD	1974	Mundangiar River	-	Yes	No	65.6
<b>STATE: HARYANA</b>										
1.	Jagadhri	89623	-	-	-	Ground Water	-	No	No	
2.	Yamuna Nagar	191980	-	-	-	"	-	No	No	
3.	Faridabad	11 lakhs	-	-	-	" G/W	Bleaching Powder	No./Yes	No.	
4.	Hisar	256800	27.00	27.00	-	River	"	Yes	13.5 MLT WTP Project	105.1
5.	Sirsa	185234	8.18	5.46	-	200 Canal based water works based on Bhakra canal system, 40 no Tubewell	-		1.5 MGD	29.5
<b>STATE : UTTAR PRADESH</b>										
1.	Allahabad	10 lakhs	135.00	85.00	1891	Yamuna River 130 Tube wells	-	Yes	No	85.0
2.	Amroha	1,64,890	-	-	-	G/W/Tubewells-	Bleaching		No	-
3.	Budaun	1,48,648	8.65	10.38	1964	G/W		Yes	No	70.0
4.	Raibareli	1,69,285	15.00	15	-	G/W		Yes	No	88.6
5.	Haridwar	1,75,000	-	-	-	T/W	Bleaching Powder	-	No	-
6.	Moradabad	6,10,000	-	-	-	G/W	Bleaching Powder		No	-
7.	Muzaffar Nagar	4,50,000	-	-	-	G/W	" "		No	-
8.	Etawah	2,11,480	-	-	-	T/W (35) Working (29)	" "	-	No	-
9.	Jhansi	3,83,248	6.00	-	1952	River/G/W	Yes	No	-	-
10	Ghaziabad	-	-	140	-	G/W	*	-	-	-
11.	Shajahanpur	3,40,000	-	-	-	T/W	-	No	No	-
12.	Sifapur	1,51,852	-	-	1955	-	-	Yes*	No	-

Sl No	Name of Town	Population (2001)	WTP Capacity		Year of installation	Water Source	Type of treatment		Plans for additional WTPs, if any	LPCD *
			Installed (MLD)	Water Treated (MLD)			Only Disinfection	Sedimentan. +Filtration +Disinfection		
13.	Maunatin Bhanhan	236000	-	-	-	G/W	-	Yes*	No	-
14.	Rishikesh	58722	10.12	10.12	1957	G/W	-	Yes	No	172.3
15.	Roorkee	97064	-	-	-	G/W	-	Yes	No	-
16.	Madinufar	144000	-	-	-	G/W	-	Yes	No	-
17.	Hapur	190000	-	-	-	G/W	-	Yes	No	-
18.	Gorakhpur	683000	66	66	1955	G/W	-	Yes	No	96.6
19.	Bahraich	171674	-	-	1949	G/W	-	Yes	No	-
20.	Aligarh	591000	Nil	Nil	-	Tubewell	-	Yes	No	-
21.	Hathras	126121	Nil	Nil	-	Tubewell	-	Yes	No	-
22.	Mathura	319000	101.00	20	2002	Yamuna, Tubewell	-	Yes	No	62.6
23.	Rampur	282000	-	-	-	Tubewell	-	Yes	No	-
24.	Buland Shah	175000	-	-	-	Ground Water, Tubewell	-	Yes	No	-
<b>STATE: MADHYA PRADESH</b>										
1.	Aizawal	339824	11.35	11.35	1988	R.Tlawna	-	Yes	22.5 MLD	33.4
2.	Darlawn Town	3925	0.227	0.227	2000	R.Tujtung	-	Yes	No	57.8
3.	Lengpui Airport town	2350	0.47	0.47	1996	R.Challui	-	-	-	280.0
4.	Serchhip Town	19885	1.84	0.51	1997	R.Tulkum	-	Yes	-	25.7
5.	Kolasib Town	18663	2.33	2.33	1999	R.Tuichhuahem	-	Yes	-	124.8
6.	Khawzawal	9228	-	-	-	R.Changelthis Damdia	Bleaching powder	-	-	-
7.	Saitual Town	10363	-	-	-	R.Maite Zotai	do	-	-	-
8.	Lunglei Town	47355	9.00	2.25	1998	R.Tilwana	-	Yes	-	47.5

Sl No	Name of Town	Population (2001)	WTP Capacity		Year of installation	Water Source	Type of treatment		Plans for additional WTPs, if any	LPCD *
			Installed (MLD)	Water Treated (MLD)			Only Disinfection	Sedimentan. +Filtration +Disinfection		
<b>STATE: MAHARASHTRA</b>										
1	Mehkar	40000	4.20	4.2	1965	Koradi Dam	-	Yes*	No	105.0
2	Dahanu	35000	7.20	6.00	1996	Sakhare Dam	-	Yes	No	171.4
3	Umrer	49573	5.60	5.60	1974	Pandharabrdi	-	Yes	No	113.0
4	Rajapur	15000	1.8	1.8	-	River	-	Yes*	No	120.0
5	Murgud	10285	2.328	1.0	-	Sir Pirajirao Tank	-	Yes*	No	97.2
6	Kalamnuri	20627	-	-	-	Isapur Dam	-	Yes	No	-
7	Mangrulpur	26000	4.25	3.00	1980	Mofsawanga Dam	-	Yes	No	115.4
8	Gadhinglaj	25356	6.46	3.00	1988	Hirevkeshi River	-	Yes*	No	118.3
9	Ausa	31000	3.60	1	1998	Tawagi River	-	yes	No	32.3
10	Omevga	30183	-	-	-	River , G/W	-	Yes*	No	-
11	Shirpur	61000	4.8	4.8	1,987	Tapi River	-	Yes*	No	76.7
12	Malkapur	5503	-	-	-	Kadavi & River Shali	-	Yes*	No	-
13	Darwha	23360	5.0	5.0	1994	River	-	Yes	No	214.0
14.	Pandhar Khawada	27000	1.68		1917		-	Yes	No	100.0
15.	Savda	19331	4.0	3.6	1999	Tapi River	-	Yes	No	186.3
16.	Shegoan	52000	4.8	2.4	-	Labara River	-	Yes	No	46.2
17.	Navapur	30000	-	-	-	Rangawali	-	Yes*	No	-
18.	Baramath	51342	6.56	5.2	1969	Nira left canal	-	Yes*	No	90.7
19.	Digras	40000	3.00	3.00	1979	Nandga	-	Yes	No	75.0
20.	Chopda	60000	10.5	4.5	1995	Tapi River	-	Yes	No	75.0
21.	Anjan goan surji	-	-	-	-	T/W	-	Yes*	No	-
22.	Sawantwadi	23,900	3.00	3.00	1980	Palankond Dam	-	Yes	1.0 MLD	125.0

Sl No	Name of Town	Population (2001)	WTP Capacity		Year of installation	Water Source	Type of treatment		Plans for additional WTPs, if any	LPCD *
			Installed (MLD)	Water Treated (MLD)			Only Disinfection	Sedimentan. +Filtration +Disinfection		
23.	Nallasopara	184000	14.4	14.4	1985	Dam(Pelhar)	-	Yes	No	78.3
24.	Kamptee	84340	27 MLD	6 MLD	-	Kanllan River	-	-	-	71.2
25.	Latur	299,000	29.08	24.0	-	Manjra River/Borewell Hand-339 power-338	-	Yes	Workers Progress 80 MLD	80.3
26.	Solapur	8.5 lacs	80.00	65.00	1998	Ujani Dam	-	Yes	No	-
			27.24	90.00	1968-69	Bhima River	-	Yes	No	213.0
				26.00	1946	Lake	-	Yes	No	
27.	Kolhapur	4,84,101	10.0	85.00	1949	Bhogavari River	-	Yes	60 MLD	175.6
			10.0		1962	Panchganga River kalamba lake				
			10.0		1975					
			11.0		1988					
			36.0		1978					
			8.0		1981-83					
28	Akola	426400	12.96	8.00	1982	Morna/Kaulkhed	H.W -	Yes	WTP are being maintained y MJP	105.5
			25.20			Mohan kutepura				
			65.0	37.0		Dam				
29	Ichalkaranji	475000	54	42	1956	The Pancha	-	Yes	54 MLD	88.4
					1975	ganya				
					1987	River/Bores				
30	Bhusawal	172304	22	22	1958	Tapi River	Liquid Cl2	-	Approved on Govt or Maharashtra estimated gross Rs 3300 lakhs	127.7
31	Malegaon	4,09,109	28	22.5	1976	Girna/ Chank Mardam river	-	Yes		55.0
32	Sangli miraj	436639	46	41.00	1958	Krishna River	-	Yes	New Plans for WTPs is prepared	137.4
33	Nashik	1152048	81	219.5	1942, 94,96	Godavari River	-	yes	48.5 MLD	190.5
			49		,97,99,2000	Darna River			26 MLD,	
			41		1940,1995				32MLD, 22	
			48.5		2001				MLD(128.5)	

Sl No	Name of Town	Population (2001)	WTP Capacity		Year of installation	Water Source	Type of treatment		Plans for additional WTPs, if any	LPCD *
			Installed (MLD)	Water Treated (MLD)			Only Disinfection	Sedimentan. +Filtration +Disinfection		
34	Wardha	120000	18.26	12.8	1970	Daham river	-	Yes	No	165.1
35	Achalpur	107304	-	-	-	Tubewell	Bleaching Powder	-	-	
36	Dhole	350000	18.0 5.0 48.0	1983.0 1965.0 1994.0	Tapi River	Nakane lake	-	Yes	WTP	80.0
37	Digras	40000	3.00	3.00	1979	Lake Nandya Dam	"	Yes	10 MLD W/S scheme in progress	75.0
38	Baramath	51342	6.56	5.2	1969	-	Bleaching Powder	Yes	Work in progress	
39	Amravath	604636	95	60	1994	Upper Warda Dam				
40	Jalgaon	3.68 lacs	30	27	1989	Girana River	-	Yes*	30 MLD project is in progress	73.4
41	Pimpri Gingwad	-	228	228	1990-2000		-	Yes	100 MLD	80.0
42	Thane	1,256,457	100	100	2001	Bhatsa River	-	Yes	No	
43	Bhiwandi Nizampur	598703	3	3 +35.0 from B.M.M.C	1954	Varala Lake	-	Yes	-	63.4
44	Pune	2.8 million	815.04	815.04	1969	Khada Kwasla Dam/Pawna	-	Yes	Wadgoan 125 WTP 100 MLD Halkar 40 MLD	291.1
45	Kopargaon	-	"	"	1998 1978	Godavari Left bank canal	-	Yes	-	
46	Ahmednagar	325,000	22 16 35	61 MLD " "	1972 1988 1997	Mula Dam	-	Yes*	No	187.7
<b>STATE : MIZORAM</b>										
1	Aizawal	339854	11.35	11.35	1988	R.Tlawna	-	Yes	22.5 MLD	33.4
2	Darlawn Town	3925	0.227	0.227	2000	R.Tujtung R.Sakeilui	-	Yes	No	57.8
3	Lengpui Airport	2350	0.47	0.47	1996	R.Challui	-	-	-	280

Sl No	Name of Town	Population (2001)	WTP Capacity		Year of installation	Water Source	Type of treatment		Plans for additional WTPs, if any	LPCD *
			Installed (MLD)	Water Treated (MLD)			Only Disinfection	Sedimentan. +Filtration +Disinfection		
	town					Hnawmpain Lui				
4	Serchhip Town	19885	1.84	0.51	1997	R. Tulkum	-	Yes	-	25.7
5	Kolasib Town	18663	2.33	2.33	1999	R.Tuichhuhahem	-	Yes	-	124.8
6	Khawzawal	9228	-	-	-	R.Changelthis Damdia	Bleaching powder	-	-	
7	Saitual Town	10363	-	-	--	R.maite Zotal	do	-	-	
8	Lunglei Town	47355	9.00	2.25	1998	R. Tilwana	-	yes	-	47.5
<b>DIFFERENT STATES</b>										
1	North Goa (Dist. Assonora)	N/A	12.0	39	1969	River and minor irrigation Dam	-	Yes	40 MLD WTP, to augment this	-
2	Chandigarh	912,617	295.0	272	1983, 1996	Bhakhm Main line	-	Yes	45 MLD STP	298.1
3	Shillong (Mehalaya)	184,425	-	-	-	G/W	Bleaching Powder	-	No	-
4	Daman	113,949	16.0	16	1994	By open canal Daman ganga	-	Yes	5 MLD	140.4
5	Panaji (Goa)	500,000	7.9 11.3 54.0	80	1957 1967 1972	River	-	Yes	No	160.0

**Annexure - 3**

**LIST OF WATER TREATMENT PLANTS VISITED (WET STUDY)**

<b>Sl no.</b>	<b>Name of Water Treatment Plants</b>	<b>Installed Capacity (mld)</b>	<b>Region</b>	<b>Remarks (Month of Visit)</b>
1.	Okhla Water Works, Delhi	86.3	North	Sept'01
2.	First Water Works, Jeevni Mandi, Agra (U.P)	250	North	Dec.'01
3.	Second Water Works, Sikandara Agra (U.P)	144	North	Dec.'01
4.	Lalpur Water Treatment Plant Jabalpur (M.P)	42	Central	Dec.'01
5.	Ranjhi Water Treatment Plant Jabalpur (M.P)	52	Central	Dec'01
6.	Bhongadwar Water Treatment Plant, Jabalpur (M.P)	27	Central	Dec.'01
7.	Benajhabar Water Treatment Plant, Kanpur (U.P)	350	North	Dec.'01
8.	Aishbagh Water Treatment Plant, Lucknow (U.P)	220	North	Dec.'01
9.	Balaganj Water Treatment Plant, Lucknow (U.P)	96	North	Dec'01
10.	Dew Dharam Filtration Plant Indore (M.P)	45	Central	Dec.'01
11.	Narmada Water Treatment Plant, Mandleshwar (M.P)	182	Central	Dec.'01
12.	Narayan Giri Water Treatment Plant, Bhopal (M.P)	23	Central	Dec.'01
13.	Kolar Water Treatment Plant Bhopal (M.P)	163	Central	Dec.'01
14.	Akilgarh Water Treatment Plant, Kota (Rajasthan)	165	West	Dec'01

Contd..



SI no.	Name of Water Treatment Plants	Installed Capacity (mld)	Region	Remarks (Month of Visit)
15.	Gumma Water Treatment Plant Shimla (H.P)	27.24	North	Jan'02
16.	Sheodaspur (Nalgonda technique) Jaipur (Rajasthan)	100 KLPD	West	Feb'02
17.	Baksawala (Activated Alumina) Jaipur (Rajasthan)	0.72/hr.	West	Feb'02
18.	Aruvikkara Water works, Trivandrum (Kerala)	158.0	South	Dec'02
19.	Theorakadam Halli WTP Bangalore (Karnataka)	900.0	South	Dec'02
20.	Hogan Halli IInd stage WTP, Mysore (Karnataka)	90.9	South	Dec.'02
21.	Asif Nagar WTP, Hyderabad (A.P)	145.5	South	Jan'03.
22.	Peddapur WTP, Hyderabad (A.P)	300.04	South	Jan'03
23.	Swarn rekha Water supply project Rukka Ranchi (Jharkhand)	113.6	East	Jan'03
24.	Ashok Nagar Filter bed Kurnool (A.P)	45.47	South	Jan'03
25.	115 MLD WTP Mundali Bhubneshwar (Orissa)	115.0	East	Jan'03
26.	Kotarpur WTP, Ahmedabad (Gujarat)	650.0	West	Jan'03
27.	Katargam Water Works, Surat ,(Gujarat)	240.0	West	Jan.'03
28.	Indira Gandhi WTP, Kolkata (W.B)	909.2	East	Feb'03
29.	Bhandup Complex WTP, Mumbai (Maharashtra)	2091.16	West	Jan'03& Feb'03
30	Aresenic Removal Plant vill Daspura block Tehsil Dhaphdhap; Dist. South, Pargana, (West Bengal)	-	East	Feb'03

**DRINKING WATER STANDARDS AS PER BUREAU OF INDIAN STANDARDS  
(BIS 10500: 1991)**

Sl. No	Substance or Characteristic	Requirement (Desirable Limit)	Permissible Limit in the absence of Alternate source
<b>ESSENTIAL CHARACTERISTICS</b>			
1.	Colour Hazen units, Max	5	25
2.	Odour	Unobjectionable	Unobjectionable
3.	Taste	Agreeable	Agreeable
4.	Turbidity NTU, Max	5	10
5.	pH Value	6.5 to 8.5	No Relaxation
6.	Total Hardness (as CaCO <sub>3</sub> ) mg/lit., Max	300	600
7.	Iron (as Fe) mg/l, Max	0.3	1.0
8.	Chlorides (as Cl) mg/l, Max.	250	1000
9.	Residual free chlorine mg/l, Min	0.2	--
<b>DESIRABLE CHARACTERISTICS</b>			
10.	Dissolved solids mg/l, Max	500	2000
11.	Calcium (as Ca) mg/l, Max	75	200
12.	Copper (as Cu) mg/l, Max	0.05	1.5
13.	Manganese (as Mn) mg/l, Max	0.10	0.3
14.	Sulfate (as SO <sub>4</sub> ) mg/l, Max	200	400
15.	Nitrate (as NO <sub>3</sub> ) mg/l, Max	45	100
16.	Fluoride (as F) mg/l, Max	1.9	1.5
17.	Phenolic Compounds (as C <sub>6</sub> H <sub>5</sub> OH) mg/l, Max.	0.001	0.002
18.	Mercury (as Hg) mg/l, Max	0.001	No relaxation
19.	Cadmium (as Cd) mg/l, Max	0.01	No relaxation
20.	Selenium (as Se) mg/l, Max	0.01	No relaxation
21.	Arsenic (as As) mg/l, Max	0.05	No relaxation
22.	Cyanide (as CN) mg/l, Max	0.05	No relaxation
23.	Lead (as Pb) mg/l, Max	0.05	No relaxation
24.	Zinc (as Zn) mg/l, Max	5	15

Sl. No	Substance or Characteristic	Requirement (Desirable Limit)	Permissible Limit in the absence of Alternate source
25.	Anionic detergents (as MBAS) mg/l, Max	0.2	1.0
26.	Chromium (as Cr <sup>6+</sup> ) mg/l, Max	0.05	No relaxation
27.	Polynuclear aromatic hydro carbons (as PAH) g/l, Max	--	--
28.	Mineral Oil mg/l, Max	0.01	0.03
29.	Pesticides mg/l, Max	Absent	0.001
30.	Radioactive Materials		
	i. Alpha emitters Bq/l, Max	--	0.1
	ii. Beta emitters pci/l, Max	--	1.0
31.	Alkalinity mg/lit. Max	200	600
32.	Aluminium (as Al) mg/l, Max	0.03	0.2
33.	Boron mg/l, Max	1	5

## **BACTERIOLOGICAL STANDARDS**

### **I. Water entering the Distribution system**

Coliform count in any sample of 100 ml should be Zero. A sample of the water entering the distribution system that does not conform to this standard calls for an immediate investigation in to both the efficacy of the purification process and the method of sampling.

### **II. Water in the distribution system**

1. E.coli count in 100ml of any sample should be zero.
2. Coliform organisms not more than 10 per 100 ml in any sample.
3. Coliform organisms should not be present in 100 ml of any two Consecutive samples or more than 5% of the samples collected for the year

**GUIDELINES RECOMMENDED BY CENTRAL PUBLIC HEALTH &  
ENVIRONMENTAL ENGINEERING ORGANISATION AS RECOMMENDED BY  
WORLD HEALTH ORGANISATION**

S.No.	Characteristics	*Acceptable	**Cause for Rejection
1	Turbidity (NTU)	1	10
2	Colour (Units on Platinum Cobalt scale)	5	25
3	Taste and Odour	Unobjectionable	Objectionable
4	pH	7.0 to 8.5	<6.5 or >9.2
5	Total dissolved solids (mg/l)	500	2000
6	Total hardness (as CaCO <sub>3</sub> ) (mg/l)	200	600
7	Chlorides (as Cl) (mg/l)	200	1000
8	Sulphates (as SO <sub>4</sub> ) (mg/l)	200	400
9	Fluorides (as F) (mg/l)	1.0	1.5
10	Nitrates (as NO <sub>3</sub> ) (mg/l)	45	45
11	Calcium (as Ca) (mg/l)	75	200
12	Magnesium (as Mg) (mg/l)	≤ 30	150
13	Iron (as Fe) (mg/l)	0.1	1.0
14	Manganese (as Mn) (mg/l)	0.1	0.5
15	Copper (as Cu) (mg/l)	0.1	1.5
16	Aluminium (as Al) (mg/l)	0.0	0.2
17	Alkalinity (mg/l)	200	600
18	Residual Chlorine (mg/l)	0.2	>1.0
19	Zinc (as Zn) (mg/l)	5.0	15.0
20	Phenolic compounds (as Phenol) (mg/l)	0.001	0.0002
21	Anionic detergents (mg/l) (as MBAS)	0.2	1.0
22	Mineral Oil (mg/l)	0.0	0.0
<b>TOXIC MATERIALS</b>			
23	Arsenic (as As) (mg/l)	0.01	0.05
24	Cadmium (as Cd)(mg/l)	0.01	0.01
25	Chromium (as hexavalent Cr) (mg/l)	0.05	0.05
26	Cyanides (as CN) (mg/l)	0.05	0.05
27	Lead (as Pb) (mg/l)	0.05	0.05
28	Selenium (as Se) (mg/l)	0.01	0.01
29	Mercury (total as Hg) (mg/l)	0.001	0.001
30	Polynuclear aromatic hydro carbons (PAH) (µg/l)	0.2	0.2
31	Pesticides (total, mg/l)	Absent	Refer to WHO guidelines for drinking water quality Vol. I 1993

<b>RADIO ACTIVITY +</b>			
32	Gross Alpha activity (Bq/l)	0.1	0.1
33	Gross Beta activity (Bq/l)	1.0	1.0
<b>Notes:</b>			
*	The figures indicated under the column 'Acceptable' are the limits upto which water is generally acceptable to the consumers		
**	Figures in excess of those mentioned under 'Acceptable' render the water not acceptable, But still may be tolerated in the absence of an alternative and better source but up to the limits indicated under column "Cause for Rejection" above which the sources will have to be rejected.		
+	It is possible that some mine and spring water may exceed these radio activity limits and in such cases it is necessary to analyze the individual radio-nuclides in order to assess the acceptability to otherwise for public consumption		
<b>BACTERIOLOGICAL GUIDELINES</b>			
<b>Bacteriological Quality of Drinking Water</b>			
	<b>Organisms</b>	<b>Guideline value</b>	
	All water intended for drinking		
	E.coli or thermo tolerant coliform bacteria	Multiple not be detectable in any 100-ml sample	
<b>Treated water entering the distribution system</b>			
	E.coli or thermo tolerant coliform bacteria	Must not be detectable in any 100-ml sample	
	Total coliform bacteria	Must not be detectable in any 100-ml sample. In case of large supplies, where sufficient samples are examined, must not be present in 95% of samples taken throughout any 12 month period	

**Source:** WHO guidelines for Drinking Water Quality (Vol.1-1993.)

## CONTRIBUTORS

<i>Over all Supervision</i>	:	Dr. B. Sengupta, <i>Member Secretary</i>
<i>Project Coordinators</i>	:	Sh. N.K. Verma, <i>Ex. Additional Director</i>
	:	Dr. D. D. Basu. <i>Senior Scientist</i>
<i>Report Finalisation &amp; Editing</i>	:	Sh. P. M. Ansari, <i>Additional Director</i>
	:	Sh. Paritosh Kumar, <i>Senior Environmental Engineer</i>
<i>Report Preparation</i>	:	Sh.G. Thirumurthy, <i>Assistant Environmental Engineer</i>
<i>Secretarial Assistance</i>	:	Sh. Atul Sharma, <i>Junior Lab Assistant</i>
	:	Ms. Gayithri H.V, <i>Junior Research Fellow</i>